

MOVE

In-the-ear hearing instruments

INSTRUCTIONS FOR USE

bernafon[®]
Your hearing · Our passion

Summary

Operating Instructions for ITE (In-the-Ear) Hearing Instruments

Features	4
Inserting Instrument	5
Removing Instrument	7
ON/OFF	8
Volume Control	9
Volume Control Indicator	10
Push Button	10
Telecoil	11
Battery Indicator	13
Battery Replacement	13
Battery Information	14
Tracker (Data Logging)	15
Safety Guidelines	16
International Warranty	18
Push Button Configuration	19

Congratulations on the purchase of your new hearing instruments. These advanced devices are fully digital and have been adjusted by your Hearing Care Professional with the aid of a computer and specially developed software. They are custom made to fit your specific hearing needs.

Please follow these instructions when using and caring for your new hearing instruments. These guidelines will help you to achieve the best possible results from your instruments and to once again enjoy the sounds of life ... your family, friends and environment.

Important

Please read the entire content of these instructions as well as the attached "Guide for better Hearing" before using your hearing instruments.

The following hearing instruments are covered by these operating instructions:



MOVE 400 CIC



MOVE 305 ITC DM



MOVE 315/355 ITC DM VC

Note: Custom hearing instruments vary in size and shape due to the unique characteristics of individual ears.

Description of features

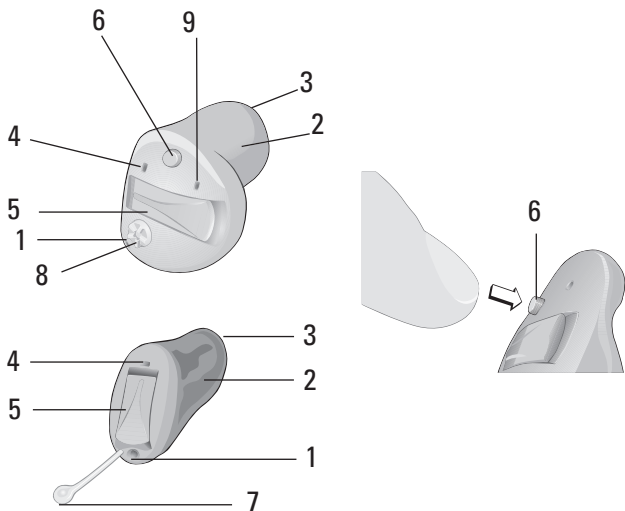

- 1 Vent
- 2 Canal
- 3 Sound outlet with Wax Protection
- 4 Microphone opening
- 5 Battery drawer
- 6 Push button (MOVE 305/315/355 only)
- 7 Pull out string
- 8 Volume control (MOVE 315/355 only)
- 9 Second microphone opening (MOVE 305/315/355 only)

Inserting your hearing instrument

Inserting your hearing instruments correctly every time takes ***practice, patience and perseverance.***

If you are having difficulty inserting your hearing instruments, please consult your Hearing Care Professional.

- The right instrument has a red marking, the left instrument has a blue marking.

- Insert your right hearing instrument with your right hand. Use your left hand for the left instrument.

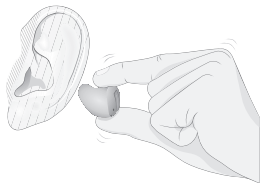

- Hold your hearing instrument between your thumb and index finger with the microphone towards the top.

- Place the canal part of your hearing instrument into your ear canal.



- Gently pull your ear lobe down with the other hand while pushing the hearing instrument in until it feels secure.

- If your ear is becoming sore from trying to insert the hearing instrument, spread a small amount of Vaseline around the outer edges of the canal of the hearing instrument. This should help it slip into position more easily. Be careful not to get any Vaseline into the sound outlet or on the front of the hearing instrument where the microphone and controls are. If your ear remains sore, please consult your Hearing Care Professional.
- If you have difficulty inserting the hearing instrument, pull the top of the ear back and up with your other hand while continuing to gently push the hearing instrument into the ear.

Removing your hearing instrument

- Gently use your thumb to push up against the bottom (back part) of your ear to loosen the hearing instrument.
- Grasp the hearing instrument at its edge between your thumb and forefinger, and gently remove it from your ear.
- If your hearing instrument has a removal (pull-out) string, pull it gently.

Important

Do not try to remove your hearing instrument by pulling on the battery drawer. This may cause damage. In case of problems when removing the hearing instrument, contact your Hearing Care Professional.

ON/OFF control

ON:

Close the battery drawer securely. Push it down until it snaps closed. The hearing instrument will make one long beep.

OFF:

Place your fingernail underneath the front edge of the battery drawer and lift to open.

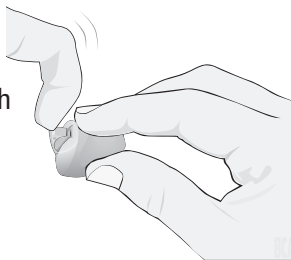

open
(OFF)

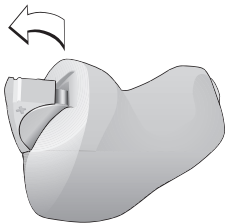

closed
(ON)

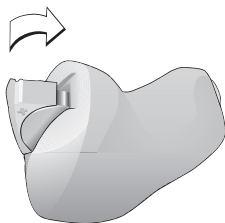

Note: Never force the battery drawer open or closed.

Volume control (MOVE 315/355)

If your hearing instrument has a volume control, then the following instructions apply.

To increase the volume: Turn the volume control towards your front.

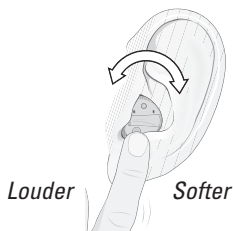

To decrease the volume: Turn the volume control towards your back.

The volume control has no mechanical stop. This means that you can continue to turn it, but the loudness will only be altered between the programmed minimum and maximum.

Note: The instrument loudness level will reset when the battery is low, the battery drawer is opened or if the program is changed. If the instrument resets, it will automatically default to the preset loudness level.

Your Hearing Care Professional can program the volume control to remain at a fixed level, if desired.

Note: If you find that you are frequently turning the volume control up or frequently turning the volume control down in most listening situations then consult your Hearing Care Professional for a possible adjustment of the hearing instrument settings.

Volume Control Indicator

Your hearing instrument will beep continuously every time you reach the programmed maximum or minimum levels with the volume control.

Push button (MOVE 305/315/355 only)

If your hearing instrument is fitted with a push button, then the following instructions apply to you.

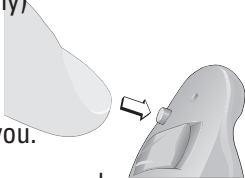

Your hearing instrument can be programmed with up to 3 different listening programs.

Use the push button to change between these programs.

When the hearing instrument is turned on it will automatically be in program 1.

Your hearing instrument will beep in the following sequence when you move between programs:

Move into Program 1: One beep

Move into Program 2: Two beeps

Move into Program 3: Three beeps

Repeat this action to cycle through the programs.

To see how your instruments are programmed see page 19.

Mute function

Press the push button and hold for 2 to 3 seconds to mute the hearing instrument. Give a short press to the push button to unmute. The hearing instrument will revert to its current program.

Telecoil

(Optional for MOVE 305 and 315/355)

If your hearing instrument is equipped with a telecoil, then please read the following:

The telecoil enables you to hear better when using the telephone or in places where inductive loop systems are installed (places of worship, halls, theaters, etc.). When the telecoil is active, you will hear directly through the inductive loop or telephone. To access the telecoil press the push button. Your Hearing Care Professional will inform you which program has the telecoil.

Typically, the microphone is automatically switched off when the telecoil is activated, to reduce any background noise. Your Hearing Care Professional can program the telecoil to function in combination with the hearing instrument microphone.

Your hearing instrument has been programmed for

- Microphone and telecoil (M+T)
- Telecoil only (T)

Note: Not all telephones are hearing instrument compatible



This symbol or a similar sign should be displayed wherever a permanent loop has been installed. Please ask your Hearing Care Professional for further information.

AutoTelephone

If your hearing instrument is fitted with an Automatic Telephone program, this system can detect a telephone signal if a magnet is placed on the receiver of your telephone.

Battery Indicator

When the battery power is about to run out, the instrument will beep at regular intervals. This warning indicates that the battery should be replaced immediately.

This option is not available in MOVE 400.

Battery replacement

- The following battery sizes are used:

MOVE 305/315/355
MOVE 400

Battery size 312
Battery size 10

- Use your fingernail to gently swing the battery drawer fully open, but do not force it.

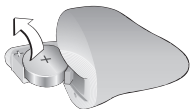

- Take out the used battery.



- Remove the colored sticker from the new battery (if applicable).

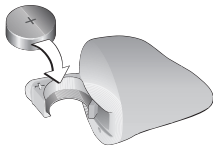

- Match flat, smooth side of battery (+ sign) to the side of the battery drawer with «+» sign.

- Slide battery into battery drawer. The battery must fit flush into the drawer.

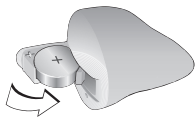

- Close battery drawer securely.

Never force the battery drawer closed.

Battery Information

- Battery life will vary with conditions of use. See your Hearing Care Professional for more information.
- Always keep spare batteries on hand. These are available from your Hearing Care Professional.
- A used battery should be replaced immediately.
- If you are not going to use your hearing instruments for a few days, remove the batteries.
- Only use batteries recommended by your Hearing Care Professional. Poor quality batteries can produce a harmful substance.
- At bedtime, or at times when you are not wearing your hearing instrument, fully open the battery drawer. This may help conserve battery power and reduce the impact of moisture.

- Any moisture found on a battery should be wiped off immediately, with a soft cloth.
- Used batteries should be returned to your battery supplier or Hearing Care Professional for disposal.
- Never dispose of batteries by burning them. There is a risk that they may explode and cause injury.
- Never dispose of batteries with household waste. They can cause environmental pollution.

Note: Always remove zinc-air batteries before drying your hearing instrument with the help of a drying kit. Drying out zinc-air batteries shortens their life time.

Tracker (Data Logging)

The Tracker (Data Logging) stores information relating to the use of your hearing instrument such as changes made to the volume control and the push button. This information can be used by your Hearing Care Professional to further adjust your hearing device to your individual needs. If you do not want this feature to be active, please ask your Hearing Care Professional to switch it off.

Safety guidelines

Hearing instruments and batteries can be dangerous if swallowed or improperly used. Such actions can result in severe injury, permanent hearing loss or even fatality.

Familiarize yourself completely with the following general warnings and the full contents of this booklet before using your hearing instruments.

- Hearing instruments should be used only as directed and adjusted by your trained Hearing Care Professional. Misuse or improper adjustments can result in sudden and permanent hearing loss.
- Never allow others to wear your hearing instruments, because they are adjusted for your hearing requirements and may permanently damage another person's hearing.
- A slap to your ear while wearing the instrument could be harmful. Avoid wearing your hearing instrument while playing contact sports (e.g. rugby, football etc.).
- Hearing instruments, their parts and batteries should be kept out of reach of anyone who might swallow these items or otherwise cause themselves injury.
- Discard batteries and keep them out of sight of infants, small children, persons of mental incapacity or pets.

- Clean your hearing instruments and their parts on a regular basis only with products that are recommended by your Hearing Care Professional. Microorganisms from unclean instruments may cause skin irritations.
- Be careful with leaking battery liquid, as it is a hazardous substance.
- Never try to recharge non-rechargeable batteries.
- Never change the battery or adjust the controls of the hearing instrument in front of infants, small children and persons of mental incapacity.
- Never put your hearing instrument or batteries in your mouth, they could easily be swallowed.
- Keep batteries away from medications. Batteries are easily mistaken for pills.
- In case a battery or hearing instrument is swallowed, see a doctor immediately.
- Be aware of the possibility that your instruments may stop functioning without notice. Keep this in mind while you circulate in traffic or otherwise depend on warning sounds.
- Never insert cleaning tools into the sound outlet or microphone inlet. This could damage the hearing instruments.

Environmental protection



Help to protect the environment by not disposing of your hearing instruments or batteries with your unsorted household waste. Please recycle your hearing instruments and batteries or return them to your Hearing Care Professional for disposal. Contact your Hearing Care Professional for more information.

International warranty



Your hearing instruments are covered by a limited warranty, covering defects in materials and workmanship. This warranty covers the hearing instruments themselves, but not accessories such as batteries, etc.

This warranty is void if a defect is the result of misuse or mistreatment.

The warranty is also void if the hearing instruments have been repaired by nonauthorized service personnel. Please review your warranty with your Hearing Care Professional and make sure that your warranty card is completed correctly.

Push button configuration

Your hearing instruments are programmed in the following way:

<i>Program</i>	<i>Beeps</i>	<i>Function</i>
1	1 	_____
2	2 	_____
3	3 	_____

Bernafon Australia Pty. Ltd.

Unit 12/97 Castlemaine Street
Milton QLD 4064
Australia
Freecall 1800 809 111
Phone +61 7 3250 0300
Fax +61 7 3250 0372
www.bernafon.com.au

Bernafon, LLC

200 Cottontail Lane, Bldg. B
Somerset, NJ 08873
USA
Phone +1 888-941-4203
Fax +1 732-560-4877
www.bernafon-us.com

Manufacturer:**Bernafon AG**

Morgenstrasse 131
3018 Bern
Switzerland
Phone +41 31 998 15 15
Fax +41 31 998 15 90
www.bernafon.com

CE 0543

**Bernafon Canada Ltd.**

500 Trillium Drive Unit 15
Kitchener, Ontario N2R 1A7
Canada
Toll free 1 800 265 8250
Phone +1 519 748 6669
Fax +1 519 748 9158
www.bernafon.ca

Bernafon UK

Cadzow Industrial Estate
Low Waters Road
Hamilton
ML3 7QE Scotland
Phone +44 1698 285 968
Fax +44 1698 421 456
www.bernafon.co.uk

Bernafon New Zealand Ltd.

Level 1, Building F
27-29 William Pickering Drive
Albany, Auckland 0632
New Zealand
Freecall 0800 442 257
Phone +64 9 920 42 40
Fax +64 9 920 42 43
www.bernafon.co.nz

www.hear-it.org

**For more information about
hearing and hearing loss**

11.08/BAG/956-78-510-00/subject to change

bernafon[®]
Your hearing • Our passion