



OTICON | More

Product Guide

Line extension, 2022

oticon
life-changing technology

More for you to offer

The new perspective in hearing care

Patients are constantly presented with sound scenes that are dynamic, complex and unpredictable. It's the brain's role to handle this complexity, to hear and to help create meaning from it all. Taking our BrainHearing™ technologies to the next level, we've created a hearing aid that works more like how the brain works, because it learned through experience. Oticon More™ is the world's first hearing aid that uses a fully trained, on-board Deep Neural Network (DNN) to process the sound scene in a more precise and balanced way. This precise approach provides the brain with optimized input from all types of meaningful sound, giving patients **better speech understanding with less effort and the ability to remember more.**

A fundamentally new approach to sound processing

To deliver the full sound scene to the brain, we have completely redefined the way we process sounds. We have recorded sound scenes from real life and used them to train a highly intelligent Deep Neural Network (DNN) that is the foundation for the sound processing technology in Oticon More.

Introducing two new groundbreaking features

Oticon More is based on the innovative Polaris™ platform and powered by Oticon's groundbreaking feature, **MoreSound Intelligence™**, which provides a quantum leap in sound scene processing. MoreSound Intelligence scans the full sound

scene 500 times per second, resulting in a precise analysis of all sounds and the complexity of the surroundings. Once the sound scene is analyzed, MoreSound Intelligence organizes the sounds around the user, and then utilizes the DNN's vast training from real life to process and create contrast between the identified sounds.

Oticon More also comes with **MoreSound Amplifier™**; a dynamic and balanced amplification system that seamlessly adapts its resolution and speed to the nature of the sound scene at hand. With a sixfold increase in resolution and an adaptive speed pilot, MoreSound Amplifier makes the full sound scene audible while maintaining the fine contrast and balance between sounds. This ensures the brain has access to the important information it needs to make sense of sound.

Amazing sound quality brings the music back to life

All this impressive technology gives Oticon More sound quality that's so good it can overcome one of the toughest challenges for hearing aids: making an outstanding music listening experience. With the Oticon MyMusic program, you can restore this universal aural pleasure to your clients.

Oticon More comes in a choice of styles, with either rechargeable lithium-ion batteries in the miniRITE R or miniBTE R styles or disposable zinc-air batteries in the miniRITE T or miniBTE T styles. All styles are available in three price points, and come with a telecoil. Hearing loss ranging from slight to profound is covered.



An outstanding selection of life-changing technology
Selecting Oticon More for a client is easier than ever with the addition of two innovative new miniBTE styles



MicroShells
Offers an integrated custom mold option for fitting levels 60 and 85 for miniRITE R and miniRITE T.



SmartCharger
Charges hearing aids from a power source or from its power bank while keeping them safe and secure.



miniFit OpenBass dome
Easier open fittings with improved sound in low and mid frequencies.

16 times more capacity to execute advanced algorithms*

Intelligent use of industry-leading 64-channel processing

Twice as much computation capacity and speed*

Deep Neural Network processing

Double the precision in 1.5-5kHz frequency bands*

Powered by **POLARIS™**

* Compared to Velox S™

Delivering the full perspective demands our most intelligent platform ever.
The Polaris platform is the backbone of Oticon More. It is purpose-built for hearing aids. This focused approach allows it to constantly run a trained DNN, while powering all the technologies in Oticon More with more speed, precision and capacity than ever possible before.



Direct streaming from iPhone® and Android™ devices
Now your patients can have seamless hands-free phone or video calls using their Oticon More hearing aids as a headset with select iPhone and iPad® devices, and direct streaming from select Android devices.*

*Android devices need to support ASHA to allow direct connectivity to Oticon More. iPhone and iPad devices need to support two-way hands-free communication. Please visit [oticon.com/support/compatibility](https://www.oticon.com/support/compatibility) for more information and to see which devices are compatible.

Contents

INTRODUCTION

TECHNOLOGY & FEATURES

INSTRUMENTS

CONNECTIVITY & ACCESSORIES

MoreSound Intelligence™



A quantum leap in signal processing

Oticon More features a groundbreaking technology, MoreSound Intelligence, that makes it easier for the brain to separate sounds and focus on what is important. MoreSound Intelligence consists of three parts: Scan and Analyze, Spatial Clarity Processing and Neural Clarity Processing. All three parts work together to provide the brain a more precise and natural representation of all sounds in the environment. This helps the brain orient and focus better with clear information that makes it easier to make sense of sound for improved speech understanding.

1. Scan and analyze

- Scans the full sound scene 500 times per second to capture a precise analysis of all sounds
- Calculates the signal-to-noise ratio and noise levels to determine the complexity of the environment
- Benchmarks level of complexity against patient's personal listening preferences established in Genie 2

2. Spatial Clarity Processing

Once the environment is scanned and analyzed the information is passed over to Spatial Clarity Processing. Spatial Clarity Processing includes two main technologies: Virtual Outer Ear and Spatial Balancer.

The complexity of the environment and the patient's personal listening preferences determines which is active. In easy environments Virtual Outer Ear is active and in more complex environments Spatial Balancer takes over.

Virtual Outer Ear

- Active in easy environments
- Helps recreate natural spatial cues provided by the pinna
- Models the filtering of real human pinnae to ensure the sound scene is reproduced based on accurate and natural spatial information
- Includes the choice of three different true-to-life pinna models that can be chosen based upon patient's needs

Spatial Balancer

- A more powerful feature for more difficult environments
- Quickly balances distinct sound sources in the environment, even when they are moving
- Makes sure meaningful sounds remain accessible and stay balanced precisely against dominating noises around the user

3. Neural Clarity Processing

With Neural Clarity Processing, sound is processed by the Deep Neural Network (DNN) embedded on the chip. It uses this highly intelligent on-board DNN to process sound instead of algorithms written and developed by engineers.

The DNN:

- Trained with 12 million real-life sound scenes to learn how to process sounds more like the brain does
- Precisely analyzes intricate details of virtually all sounds, to find complex patterns in a sound scene
- Knows how to represent sounds naturally and with clarity, with better contrast and balance.

Sound Enhancer

Working with both Spatial Clarity and Neural Clarity processing, Sound Enhancer provides more details or more comfort in difficult situations based on user preference by dynamically adding sound detail.

- Gives extra gain for speech sounds in the 1-4 kHz regions in difficult situations

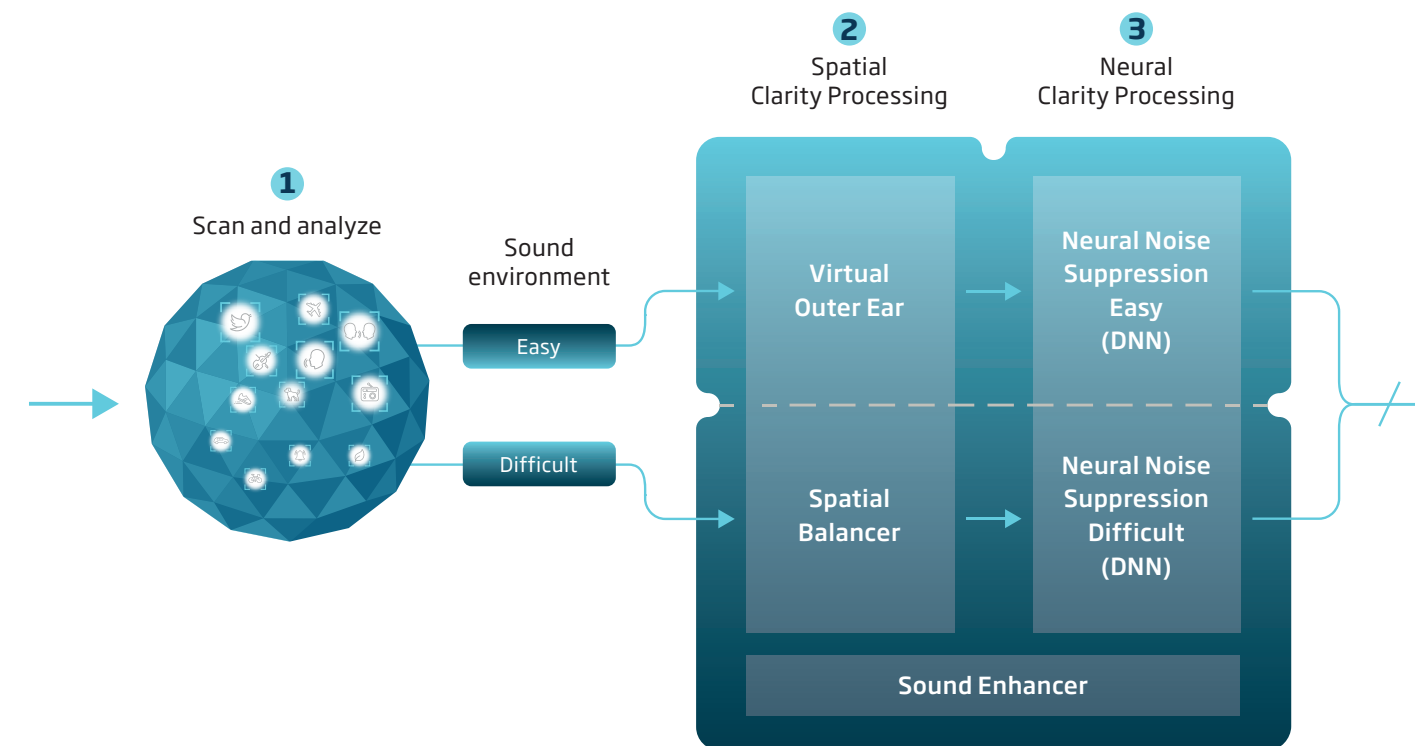

*Brændgaard. 2020a.
** Santurette & Behrens. 2020.



“ TELL YOUR CLIENT

The new way of processing sound results in a more natural representation of all sounds in a clear, complete, and balanced sound scene.

MoreSound Intelligence in Oticon Genie 2

Fine-tuning for user needs

In Oticon Genie 2, the fitting screen MoreSound Intelligence provides the hearing care professional with different handles to fine-tune the settings of the hearing aid to make the most optimal fitting for each individual user. This brand-new addition to Genie 2 is a tool that was developed with user feedback and is designed to optimize ease of use and simplicity without compromising the need for extensive customization options and fitting handles.

The adjustment of the first three handles mentioned here can be considered in the first fitting session after having a dialogue with the user. The last two handles are preference handles which can be adjusted at later visits based on user feedback after trying the hearing aids in daily life.

1. Environment Configuration

Use the Environment Configuration slider to specify which hearing situations the user finds easy and difficult. The way sound is handled will differ substantially between the Easy and Difficult categories.

2. Neural Noise Suppression - Easy

Ambient noise suppression in easy environments provided by the DNN. Creates clearer contrasts in sound between the background and the foreground around the user where less help from the hearing aid is needed.

3. Neural Noise Suppression – Difficult

Ambient noise suppression in difficult environments provided by the DNN. Creates clearer contrasts in sound between the background and the foreground around the user where more help from the hearing aid is needed.

4. Virtual Outer Ear

Three true-to-life and very accurate pinna simulations. Provides the user the option of more or less frontal focus or awareness of all sounds around them. The Balanced setting is default. Applies to easy environments.

5. Sound Enhancer

Provides dynamic sound detail, based on user preference, when noise suppression is active. Added detail is mainly provided in the 1-4 kHz area, primarily enhancing speech sounds. Applies to difficult environments.

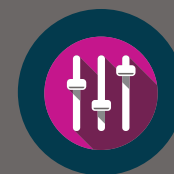

“ TELL YOUR CLIENT

Oticon More comes with plenty of fine-tuning options to make the fitting just right for you.

The Deep Neural Network

Optimal support for the brain

Oticon More utilizes the intelligent capabilities of a fully trained Deep Neural Network. Just like the human brain needs to learn, the DNN also needs to learn. When the DNN has been trained and has learned how to process sound scenes it can use this knowledge to process any sound scene presented to it. It is an intelligent feature that outperforms man-made algorithms.

The sound scenes used for the training of the DNN were real-life sound scenes recorded using a spherical microphone. A spherical microphone has 32 advanced, individual microphones evenly distributed across the sphere. This makes it possible to record sound scenes with spatial detail and accuracy.

Once collected, 12 million sound scenes were used to train the DNN. The sound scenes were fed to the DNN and the output from the DNN was then compared to a known target, indicating to the DNN if the processing was good or bad. Based on the feedback provided to the DNN, the processing was adjusted until the optimal target was reached.

It is important that a DNN is trained sufficiently for the given task – it should not be either under or overtrained. If it is undertrained, it will not have enough knowledge to handle all sound scenes and will therefore make many errors. If it is overtrained, it will be too specialized to handle real life sound scenes different from what was used in the training. To make sure the DNN is trained to the right level, it has been trained in the development phase. The DNN has completed its training when the hearing aid is worn by the user.

The DNN is embedded on the chip so that all the incoming sounds in the sound scenes around the user can be processed incredibly fast. The DNN processes 500 inputs each second.

A Deep Neural Network enables the sounds of the world to be handled precisely and automatically. This optimizes the way Oticon More makes sounds more distinct, working seamlessly across varying listening environments. With this integrated intelligence, Oticon More has learned to recognize all types of sounds, their details, and how they should ideally sound – all in order to optimally support the brain.

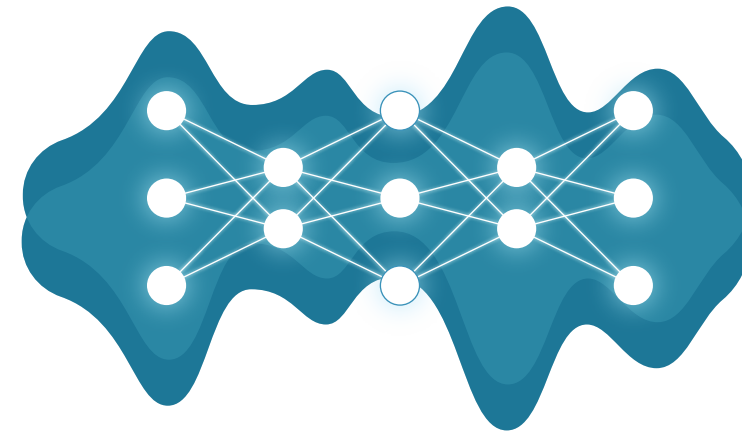

For more information on DNN, please see Brændgaard, M. 2020. MoreSound Intelligence. Oticon Tech Paper

MoreSound Amplifier™

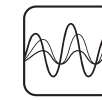

Rapid high-resolution amplification

MoreSound Amplifier is a dynamic and balanced amplification system that seamlessly adapts its resolution and speed to the nature of the prevailing sound scene.

With a sixfold increase in resolution and an adaptive speed pilot, MoreSound Amplifier makes the full sound scene audible while maintaining the fine contrast and balance between sounds.

Sounds are constantly processed through two different paths – a 4-channel path and a 24-channel path. The system constantly identifies which type of information is present and what resolution (which path) should be prioritized when amplifying making it easier for the brain to access the information. As an example, when processing speech which changes rapidly in both amplitude, frequency, and time, we need to prioritize high precision in time, so processing in the 4-channel path is chosen. This safeguards the speech envelope. However, if a steady narrow band noise is present, which does not change much in either amplitude or frequency, we need to prioritize high precision in frequency, so processing in the 24-channel path is chosen. A steady narrow band noise could be a typical everyday alarm tone which will then be handled in a narrow frequency range to be amplified correctly without disrupting amplification of sounds in neighboring frequency channels.

This constant priority of processing paths depending on the incoming signal ensures the brain has access to the important information it needs to make sense of sound.

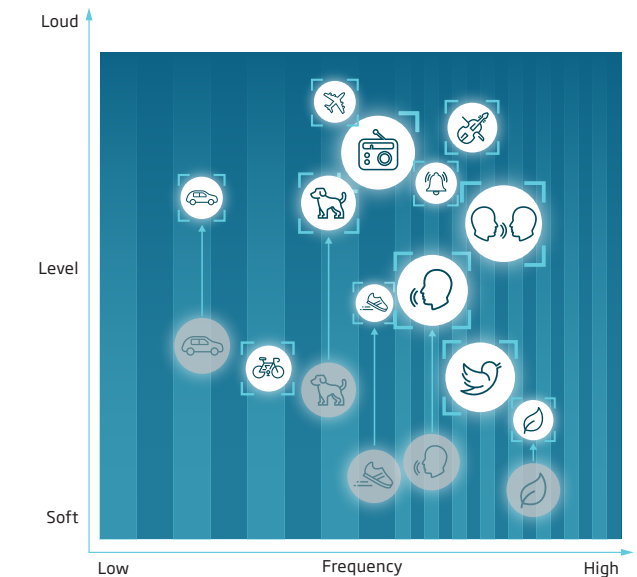

“ TELL YOUR CLIENT

A Deep Neural Network creates contrast between sounds, making it easier for you to separate sounds.



“ TELL YOUR CLIENT

The dynamic and balanced amplification system ensures the full sound scene is audible.

MoreSound Optimizer™

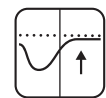

Optimal gain all day, without the risk of feedback*

The extremely fast MoreSound Optimizer breaks the feedback loop by detecting and preventing feedback proactively, before it occurs. This makes it possible for the hearing aid to provide optimal gain all day while eliminating the risk of feedback and invisible gain reductions caused by the feedback management system due to normal, dynamic movements in and around the head and neck.

The technology in MoreSound Optimizer represents a breakthrough in accessing speech details with more natural sound, increased comfort, and improved speech understanding – even in the most challenging listening environments. MoreSound Optimizer protects the sound quality by using ultra-fast signal processing:

- Predicts acoustic response by performing rapid measurements in 28 independent channels
- Counters detected acoustic changes immediately using targeted breaker signals in one or more frequency channels
- Stops breaker signal as soon as the acoustic response is stabilized

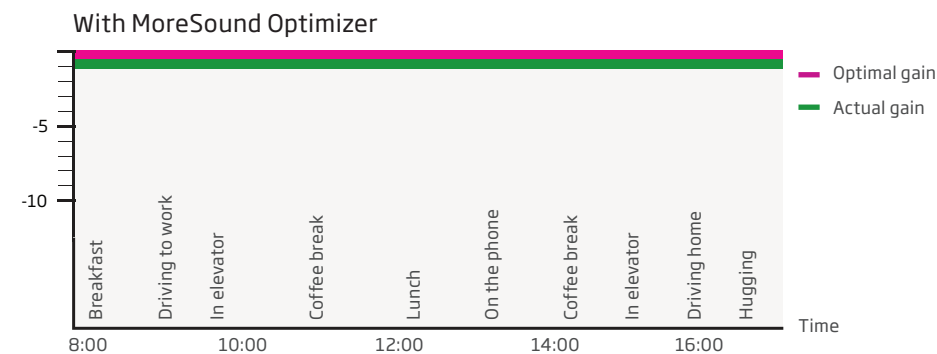
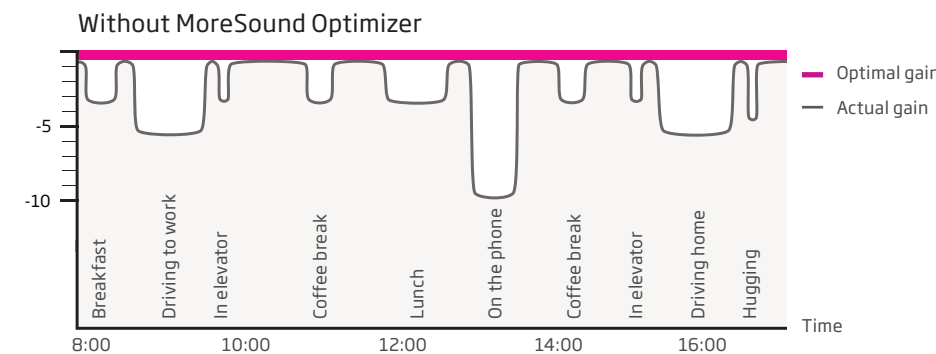

MoreSound Optimizer offers three different settings: Normal, Low, and Off. Each can be set in Oticon Genie 2 for individual programs. Normal is the recommended setting. The normal setting provides the full benefit of the system and a fitting with optimal gain and no feedback. Low is an alternative setting that might be suitable for musicians or others who find that MoreSound Optimizer affects the sound quality in specific situations. Off turns the entire feedback management system off and might result in audible feedback.

MoreSound Optimizer works with Feedback shield to avoid false detections. See the section on Feedback shield for details.

Spatial Sound™



Locate the sounds of interest

Spatial Sound combines several advanced technologies to provide a more precise spatial awareness to help users identify where sound is coming from.

Using the energy-efficient and fast binaural communication offered by NFMI, Spatial Sound preserves interaural level differences in four frequency bands. This maintains the sense of location and direction naturally provided by the head shadow effect.

The multi-band analysis prevents low frequencies from masking higher frequencies. This ensures that interaural differences are preserved over the entire frequency spectrum.

As part of Spatial Sound, Better-Ear Priority emphasizes sounds on the better ear in asymmetrical noise situations.

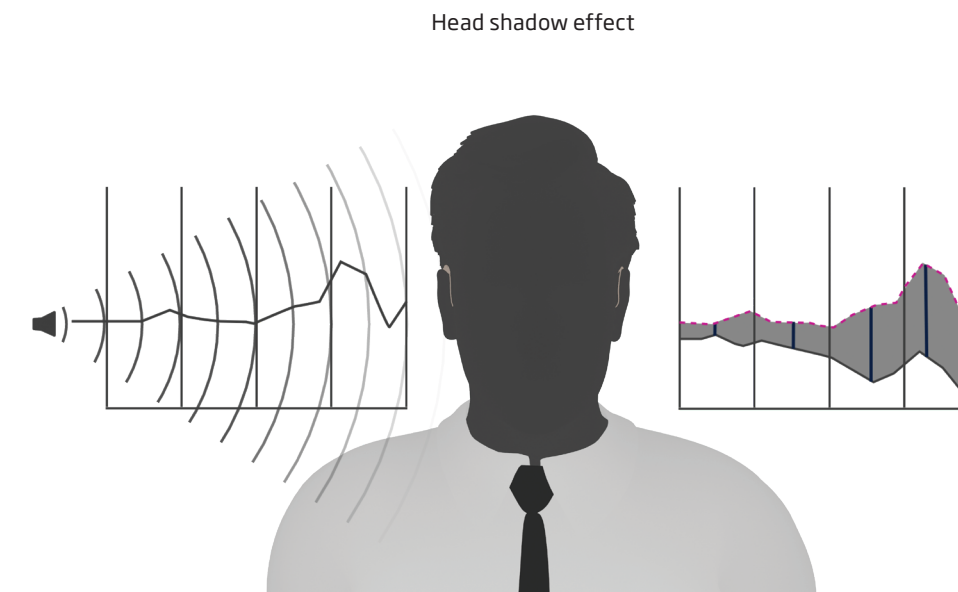

TELL YOUR CLIENT

This super-fast technology ensures you can enjoy clear, stable sound without worrying about whistling and bad sound quality.



TELL YOUR CLIENT

Provides a richer, more realistic sound picture so you perceive the location and direction of sounds with greater ease.

Speech Rescue™



Making high frequency sounds more audible

Missing high frequency sounds such as /s/ or /sh/ can negatively impact the flow and understanding of conversation. Oticon's methodology of frequency lowering, called frequency composition, increases speech understanding by 'rescuing' speech cues that might otherwise be lost.

MoreSound Intelligence's precise ability to improve SNR makes Speech Rescue more effective in two ways: High-frequency noise is suppressed to clean the inaudible high-frequency speech, and that speech is then copied into noise-cleaned medium frequencies.

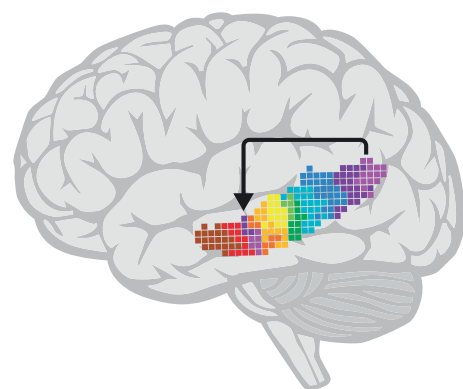

Combined with MoreSound Amplifier, this gives users with moderate to severe-to-profound hearing loss (in the high frequencies) access to inaudible high frequency sounds. The three step 'copy and keep' methodology copies inaudible high frequency sounds, places them on the edge of the maximum audible output frequency (MAOF), and ensures that the low frequencies are preserved so that vowel information and sound quality are maintained.

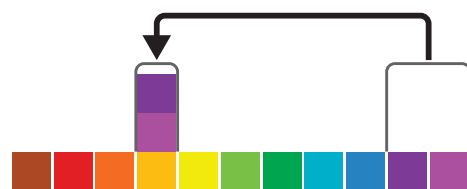

Soft Speech Booster



Improves soft speech understanding

Soft Speech Booster makes soft sounds audible to people with hearing loss. By increasing access to the soft sounds that occur in most situations and conversations, Soft Speech Booster improves soft speech understanding.

Oticon's proprietary fitting rationale, VAC+, uses multiple knee points to provide a clear focus on soft-to-moderate speech information while preserving comfortable perception of louder sounds.

Soft Speech Booster can be personalized using questions and sound files in Oticon Genie 2 to ensure a fitting matched to each user's unique perception of soft sound for the best possible balance between details and comfort.



“ TELL YOUR CLIENT

Increases speech understanding by letting you hear more speech sounds like /s/ and /sh/.



“ TELL YOUR CLIENT

Increases access to soft sounds to improve soft speech understanding without turning up the volume.

Clear Dynamics



Better sound quality with less distortion in loud environments

Clear Dynamics expands the input dynamic range, processing input sounds up to 113 dB SPL, to provide better sound quality without distortion and artifacts at loud input levels, while keeping the sound quality of soft input levels intact.

With speech cues preserved at high input levels users enjoy a better listening experience without distortion, even in loud environments. Clear Dynamics is especially valuable for users when listening to music or in conversations in busy, dynamic environments, where peaks can often be louder than the available input dynamic range.

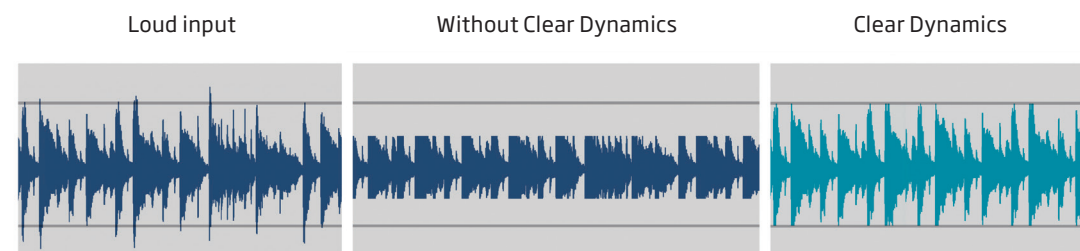

Wind Noise Management



Better access to speech in situations with wind noise

Wind Noise Management offers highly efficient wind noise suppression. High speed estimators analyze the presence of wind noise 500 times per second for fast and precise application of up to 30 dB wind noise suppression in 24 frequency channels. Wind Noise Management attenuates wind bursts in less than 50ms, making it fast enough to precisely attenuate wind between words.

The purpose of Wind Noise Management is to attenuate the wind noise and quickly ensure a stable and comfortable loudness level for hearing aid users, so they can focus on the speech that's important to them. When speech is present, the signal-to-noise ratio is preserved because wind noise is suppressed when it is louder than speech. When no speech is present, the system will aggressively suppress wind noise to ensure comfort in windy situations.

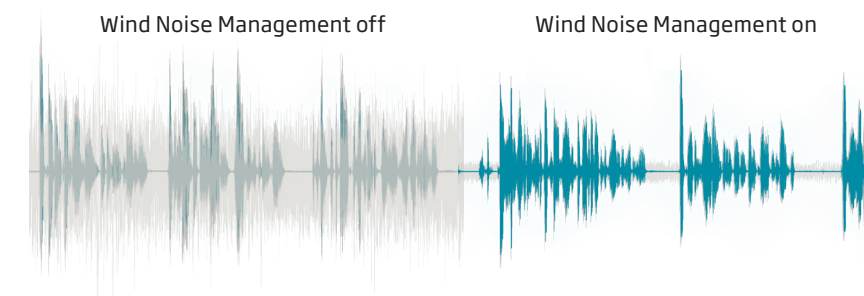

“ TELL YOUR CLIENT

Experience superior sound quality especially when you are enjoying music or engaging in conversations in noisy environments.



“ TELL YOUR CLIENT

Effectively suppresses annoying wind noise, even between the words in a conversation.

Feedback shield



Dual-microphone feedback system for reducing and suppressing feedback

Feedback shield supports MoreSound Optimizer's ultra-fast reaction and preventive abilities to avoid feedback.

Working together, the two technologies combine the strengths of rapid, proactive feedback elimination with a stable adaptive system to avoid false detections and activation of Feedback shield's gain control.

The well-known Feedback shield operates in two separate paths – one for each microphone. In each path, three distinct technologies work together to suppress feedback and ensure stable amplification. Frequency shift optimizes phase inversion, and gain control may be applied if needed. Thanks to MoreSound Optimizer, the gain control is used far less.

MoreSound Optimizer's ultra-fast detection engages pro-active modulation to instantly stabilize the system when a feedback risk emerges. If the risk is only momentary, MoreSound Optimizer disengages the modulation when the risk has passed. If the feedback risk persists, the modulation ensures that Feedback shield can adapt and stabilize. As Feedback shield engages, MoreSound Optimizer's modulation is gradually tapered off.

Combining Feedback shield and MoreSound Optimizer allows you to add more gain to reach the target. This gives you greater flexibility in the fitting process.

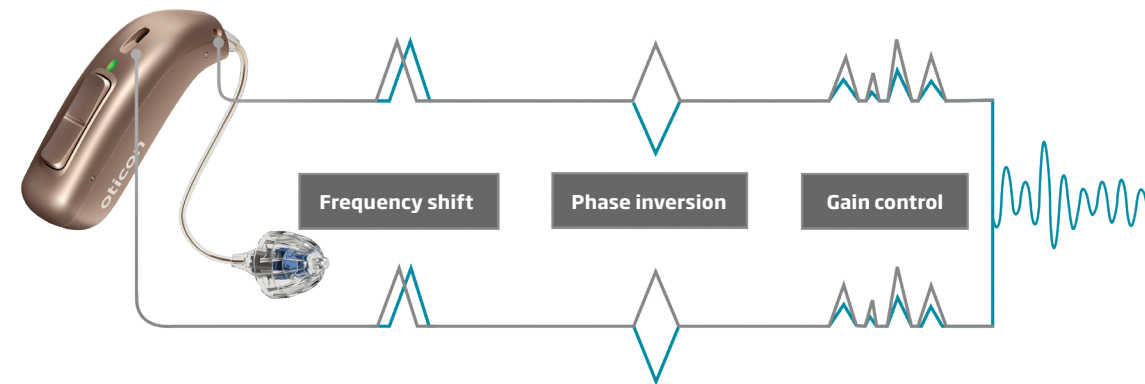

Tinnitus SoundSupport™



A variety of relief sounds to meet the unique needs of each person with tinnitus

You can enable Tinnitus SoundSupport in all performance levels.

The integrated sound generator offers a wide range of sound options including broadband sounds (shaped to audiogram, white, pink & red) and three ocean-like sounds. These nature sounds are dynamic, yet soothing, and show great promise in decreasing the annoyance of tinnitus*.

No two brains work the same and some clients require sounds that are more dynamic or have a unique quality.

Tinnitus SoundSupport aims to make fitting as simple and quick as possible while giving clients a fully personalized treatment.

You can apply four modulation options to any of the broadband sounds to create a wider variety of relief sounds to meet clients' individual needs and preferences.

Clients can adjust the volume level of relief sounds directly on the hearing aid or via the Oticon ON app. For the client, it means easy and discreet handling and adjustment of relief sounds whenever needed.

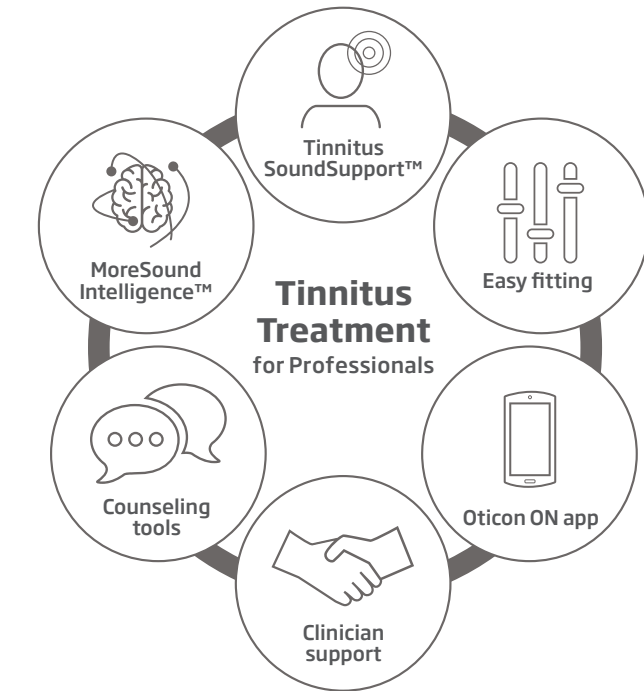

* Benefits may vary depending on the individual



TELL YOUR CLIENT

Enjoy clearer sound without worrying about annoying whistling or squealing, even in feedback-prone everyday situations like greeting someone with a hug.*

* Benefits may vary depending on hearing loss



TELL YOUR CLIENT

Tinnitus SoundSupport and MoreSound Intelligence give you the combined benefit of a balanced and rich sound experience that

makes it easier for the brain to listen and provide a powerful solution for tinnitus relief. The goal is to affect your perception of your tinnitus in a positive way.

TwinLink™

Wireless connectivity and binaural processing in a small, energy-efficient solution

TwinLink technology uses two dedicated radio systems to meet distinct communication needs.

TwinLink technology supports seamless, energy-efficient communication between two hearing aids and direct connectivity with external electronic and digital devices.

Near-Field Magnetic Induction (NFMI) enables a continuous exchange of data and audio between two hearing aids to provide advanced binaural processing. This communication is done with minimal power consumption.

With NFMI, data and audio information are exchanged 21 times per second between the two hearing aids.

Oticon hearing aids with stereo Bluetooth® Low Energy technology connect to smartphones and other digital devices for easy, seamless wireless connectivity. This technology also allows for true wireless fitting and firmware updates.



“ TELL YOUR CLIENT

Hearing aids need to communicate with each other, but also with external devices. TwinLink gives you two technologies to provide you the best of both worlds.

Feature overview

Better-Ear Priority	Optimizes listening in asymmetrical, noisy situations	Page 13	Sound Enhancer	Dynamically provides gain primarily for speech sounds in difficult environments, based on user preference	Page 8
Clear Dynamics	Expands the dynamic input range, processing sounds up to 113 dB SPL, to preserve sound quality even at loud input levels	Page 16	Spatial Sound	Preserves interaural level differences to provide precise spatial awareness that helps users identify where sounds are coming from	Page 13
Feedback shield	Employs a proven and effective feedback management system to reduce the risk of feedback and suppress feedback if it occurs	Page 18	Speech Rescue	Makes high frequency speech sounds like /s/ and /sh/ more audible using frequency composition	Page 14
MoreSound Amplifier	Sound processing occurs in an adaptive path setup that gives priority to resolution or speed, based on the current sound scene	Page 11	Tinnitus SoundSupport	Provides a variety of relief sounds, including soothing ocean sounds, to meet the individual needs of people with tinnitus	Page 19
MoreSound Booster	Provides maximum help in easier environments when needed by the user. Must be activated in the Oticon ON app	Page 39	Transient Noise Management	Protects against sudden loud sounds with fast recovery to preserve audibility. Offers four different levels for fine tuning, including 'off'	
MoreSound Intelligence	Creates a clearer and more distinct contrast between sounds by swiftly scanning and analyzing, precisely organizing the spatial sound scene, and intelligently creating contrast and suppressing unwanted noise through the embedded Deep Neural Network	Page 6	TwinLink	Combines two distinct radio technologies in an innovative wireless communication system. Features one technology to support seamless, energy-efficient binaural communication between two hearing aids (NFMI) and one to support communication with external electronic and digital devices (2.4 GHz)	Page 20
MoreSound Optimizer	Improves listening performance and comfort with ultra-fast proactive feedback detection and prevention. Enables optimal gain all day	Page 12	Virtual Outer Ear	Provides a true-to-real ear pinna simulation with three different settings for user preference	Page 8
Soft Speech Booster	Applies an individual amount of soft gain to increase soft speech understanding	Page 15	Wind Noise Management	Protects against the discomfort of wind noise	Page 17

Note: Availability of features depends on price points

60 85 100 105

The audiological difference between Oticon More 1, More 2 and More 3

New independent research* supporting our BrainHearing philosophy, confirms that the brain needs access to more. More information from the surroundings to aid the brain's natural way of working. More of the full perspective of sounds to get more out of life.

Oticon More 1, More 2 and More 3 all process sound in a way that results in a more natural sound scene. The three models differ in performance levels by the amount of help they provide for the brain.

MoreSound Intelligence scans, analyzes, and cleans sound to create a complete and balanced sound scene. The feature processes sound scenes based on which hearing situations the user finds easy or difficult. The way sound is handled differs substantially between the Easy and Difficult categories.

The effect of the system and the fine-tuning options differ between performance levels. For instance, Virtual Outer Ear, with three options in Oticon More 1, provides more fitting flexibility in easy environments. Also, the effect of Spatial Balancer, as well as that of the DNN, is greater in Oticon More 1 and provides better access to speech, more options for the release of noise, and more comfort. Fitting bandwidth and fitting bands are also larger for Oticon More 1. This performance level allows the hearing aid to be fine-tuned and personalized in the most flexible way for the individual user.

Oticon More 1 offers the greatest effect and number of options settings. It also provides maximum support for the full perspective of sounds across different sound scenes, client ages, and lifestyles. Please find the full feature overview on the next page.

* O'Sullivan, J., Herrero, J., Smith, E., Schevon, C., McKhann, G. M., Sheth, S. A., ... & Mesgarani, N. 2019. Hierarchical Encoding of Attended Auditory Objects in Multi-talker Speech Perception. *Neuron*, 104(6), 1195-1209. Hausfeld, L., Riecke, L., Valente, G., & Formisano, E. 2018. Cortical tracking of multiple streams outside the focus of attention in naturalistic auditory scenes. *NeuroImage*, 181, 617-626.

Puvvada, K. C., & Simon, J. Z. 2017. Cortical representations of speech in a multitalker auditory scene. *Journal of Neuroscience*, 37(38), 9189-9196. See also Man, B. & Ng, E. 2020. BrainHearing - The new perspective. Oticon Whitepaper.

	More 1	More 2	More 3
Speech Understanding	MoreSound Intelligence™	Level 1	Level 2
	- Environment configuration	5 Options	5 Options
	- Virtual Outer Ear	3 Configurations	1 Configuration
	- Spatial Balancer	100%	60%
	- Neural Noise Suppression, Difficult/Easy	10 dB/4 dB	6 dB/2 dB
	- Sound Enhancer	3 Configurations	2 Configurations
	MoreSound Amplifier™	•	•
	Feedback Prevention	MoreSound Optimizer™ & Feedback shield	MoreSound Optimizer™ & Feedback shield
	Spatial Sound™	4 Estimators	2 Estimators
	Soft Speech Booster	•	•
Sound Quality	Frequency lowering	Speech Rescue™	Speech Rescue™
	Clear Dynamics	•	•
	Better-Ear Priority	•	•
	Fitting Bandwidth*	10 kHz	8 kHz
	Bass Boost (streaming)	•	•
Listening Comfort	Processing Channels	64	48
	Transient Noise Management	4 configurations	3 configurations
	Wind Noise Management	•	•
Personalization & Optimizing Fitting	•	•	•
	Fitting Bands	24	20
	Multiple Directionality options	•	•
	Adaptation Manager	•	•
Connecting to the world	Fitting Formulas	VAC+, NAL-NL1/NAL-NL2, DSL 5.0	VAC+, NAL-NL1/NAL-NL2, DSL 5.0
	Hands-free communication**	•	•
	Direct streaming***	•	•
	Oticon ON & Oticon RemoteCare apps	•	•
	ConnectClip	•	•
	EduMic	•	•
	Remote Control 3.0	•	•
	TV Adapter 3.0	•	•
	Phone Adapter 2.0 (with ConnectClip)	•	•
	Tinnitus SoundSupport™	•	•
CROS/BiCROS support	•	•	

• indicates feature included

**Available for Oticon More from FW 1.1. Available with iPhone 11 or later running iOS 15.2 or later, and iPad running iPad OS 15.2 or later.

*Bandwidth accessible for gain adjustments during fitting

***From iPhone, iPad, iPod touch, and selected Android devices

123 TELL YOUR CLIENT

Oticon More makes it possible, for the first time, to give hearing aid users access to all relevant sounds. It's just a matter of choosing the right version.

Instruments



Discreet miniBTE R

Oticon More miniBTE R is Oticon's first rechargeable BTE-style powered by a lithium-ion battery. It is small and discreet, and it suits clients with slight to moderately-severe hearing loss. With new groundbreaking features, the hearing aid gives the client access to the full perspective of sounds.

Oticon More miniBTE R is a Made for iPhone® hearing aid which features two-way hands-free streaming with select iPhone and iPad devices. It is also compatible with the new Android protocol for Audio Streaming for Hearing Aids (ASHA) – making it possible to stream directly from select Android devices.* It offers a wide variety of connectivity options, as well as Tinnitus SoundSupport.

Oticon More miniBTE R features a telecoil, LED for visible activity decoding, and a single push-button for easy handling. The hearing aid is robust and reliable with a certified rating of IP68 for dust and water resistance. All vital components are nano-coated inside and out.

For Oticon More, Noahlink Wireless is used as the only programming device when fitting or performing firmware updates to the hearing aid.



* Hands-free communication is available with iPhone 11 or later running iOS 15.2 or later, and iPad running iPadOS 15.2 or later. Android devices need to support ASHA to allow direct connectivity to Oticon More.

TELL YOUR CLIENT

Choose Oticon More miniBTE R if you prefer a rechargeable BTE-style.

Disposable batteries with miniBTE T

Oticon More miniBTE T is powered by a disposable zinc-air battery and is small and discreet. It comes in a wide range of colors, and it suits clients with slight to moderately-severe hearing loss. With new groundbreaking features, the hearing aid gives the client access to the full perspective of sounds.

Oticon More miniBTE R is a Made for iPhone® hearing aid which features two-way hands-free streaming with select iPhone and iPad devices. It is also compatible with the new Android protocol for Audio Streaming for Hearing Aids (ASHA) – making it possible to stream directly from select Android devices.* It offers a wide variety of connectivity options, as well as Tinnitus SoundSupport.

Oticon More miniBTE T features a telecoil, an LED to show its status, and a single push-button for easy handling. The hearing aid is robust and reliable with a certified rating of IP68 for dust and water resistance. All vital components are nano-coated inside and out.

For Oticon More, Noahlink Wireless is used as the only programming device when fitting or performing firmware updates to the hearing aid.



* Hands-free communication is available with iPhone 11 or later running iOS 15.2 or later, and iPad running iPadOS 15.2 or later. Android devices need to support ASHA to allow direct connectivity to Oticon More. .

“ TELL YOUR CLIENT

Choose Oticon More miniBTE T if you want a small BTE-style with disposable batteries.

Easy, discreet miniRITE R

Oticon More miniRITE R is a discreet, rechargeable hearing aid with a lithium-ion battery and an easy-to-use charger. It provides a rechargeable solution for clients with slight to profound hearing loss, up to 105 dB HL. Oticon More miniRITE R comes with groundbreaking new features and functionalities that give access to the full perspective of sounds.

Oticon More miniBTE R is a Made for iPhone® hearing aid which features two-way hands-free streaming with select iPhone and iPad devices. It is also compatible with the new Android protocol for Audio Streaming for Hearing Aids (ASHA) – making it possible to stream directly from select Android devices.* It offers a wide variety of connectivity options, as well as Tinnitus SoundSupport.

Oticon More miniRITE R features a telecoil, a LED for visible activity decoding, and a convenient double push-button for easy operation of volume and programs. It is robust and reliable and has a certified rating of IP68 for dust and water resistance. All vital components are nano-coated inside and out.

For Oticon More, Noahlink Wireless is used as the only programming device when fitting or performing firmware updates to the hearing aid.



* Hands-free communication is available with iPhone 11 or later running iOS 15.2 or later, and iPad running iPadOS 15.2 or later. Android devices need to support ASHA to allow direct connectivity to Oticon More.

“ TELL YOUR CLIENT

With rechargeable Oticon More hearing aids you avoid the hassle of regularly changing small batteries.

Disposable batteries with miniRITE T

Oticon More miniRITE T is a discreet hearing aid that uses disposable zinc-air batteries. It is for clients with hearing loss ranging from slight to profound; up to 105 dB HL. Oticon More miniRITE T comes with groundbreaking new features and functionalities that give access to the full perspective of sounds.

Oticon More miniBTE R is a Made for iPhone® hearing aid which features two-way hands-free streaming with select iPhone and iPad devices. It is also compatible with the new Android protocol for Audio Streaming for Hearing Aids (ASHA) – making it possible to stream directly from select Android devices.* It offers a wide variety of connectivity options, as well as Tinnitus SoundSupport.

Oticon More miniRITE T features a telecoil, an LED to show its status, and a convenient double push-button for easy control of volume and programs. It is robust and reliable, with a certified rating of IP68 for dust and water resistance. All vital components are nano-coated inside and out.

For Oticon More, Noahlink Wireless is used as the only programming device when fitting or performing firmware updates to the hearing aid.



* Hands-free communication is available with iPhone 11 or later running iOS 15.2 or later, and iPad running iPadOS 15.2 or later. Android devices need to support ASHA to allow direct connectivity to Oticon More.

TELL YOUR CLIENT

Choose the Oticon More miniRITE T if you prefer hearing aids that use disposable batteries.

A choice of chargers

Oticon offers two different chargers for Oticon More miniRITE R and Oticon More miniBTE R: our desktop charger and our portable SmartCharger. Both chargers use inductive technology to provide reliable, fast charging* for a full day of hearing, including streaming.**

Oticon SmartCharger

The SmartCharger can be connected to a power supply or used as a power bank when a user is on the go. When fully charged, the power bank allows a user to charge a completely depleted set of hearing aids three times. Long battery life and multiple recharges provide peace of mind and security for users, even when they are away from a power supply for several days. The LED on the back indicates the charging status of the power bank when the charger is plugged in and indicates the battery level of the charger when it is unplugged and used as a power bank.

When the hearing aids are placed in the SmartCharger, they are protected by the lid during charging, transportation, and storage. Another very useful aspect of the SmartCharger is the automatic drying of the hearing aids. The hearing aids are dried as they charge.

Desk charger

The desk charger is perfect for the user who mainly needs to charge their hearing aids at home. The charger is permanently connected to a power supply. The green LED on the charger is a simple connection indicator that shows the charger is ready for use. A charger that is always 'on' makes it easy for the user to quickly place their hearing aids in the charger for an overnight charge, or for a quick recharge at any time.



Oticon SmartCharger for miniBTE R

Oticon SmartCharger for miniRITE R



Desk charger for miniBTE R

Desk charger for miniRITE R

TELL YOUR CLIENT

The SmartCharger is easy to take with you and even charges your hearing aids without a power outlet.

* Three hours charging for miniRITE R and three and a half hours charging for miniBTE R.

** The expected operating time for the rechargeable battery depends on use pattern, active feature set, hearing loss, sound environment, battery age, and use of wireless accessories.

Oticon More overview



Style	miniBTE R	miniBTE T	miniRITE R	miniRITE T
Battery	Lithium-ion	Zinc-air	Lithium-ion	Zinc-air
Expected operating time (h)*	24		24	
Rechargeable	•		•	
Wireless 2.4 GHz Bluetooth technology	•	•	•	•
Directionality settings	•	•	•	•
Program control	•	•	•	•
Volume control	•	•	•	•
Direct streaming**	•	•	•	•
Telecoil	•	•	•	•
Hardware certification	IP68 - Water and dust resistant	IP68 - Water and dust resistant	IP68 - Water and dust resistant	IP68 - Water and dust resistant
Oticon ON app	•	•	•	•
Oticon RemoteCare app	•	•	•	•
ConnectClip	•	•	•	•
TV Adapter 3.0	•	•	•	•
Remote Control 3.0	•	•	•	•
EduMic	•	•	•	•
Phone Adapter 2.0 (in combination with ConnectClip)	•	•	•	•
Wireless fitting and firmware update	Noahlink Wireless	Noahlink Wireless	Noahlink Wireless	Noahlink Wireless
CROS/BiCROS support	•	•	•	•

• Indicates feature included

* The expected operating time for the rechargeable battery depends on use pattern, active feature set, hearing loss, sound environment, battery age, and use of wireless accessories.

** From iPhone, iPad, iPod touch, and selected Android devices. Android devices need to support Audio Streaming for Hearing Aids (ASHA) to allow direct streaming to Oticon More. Please visit oticon.com/support/compatibility for more information.

Oticon More fitting range*

miniRITE

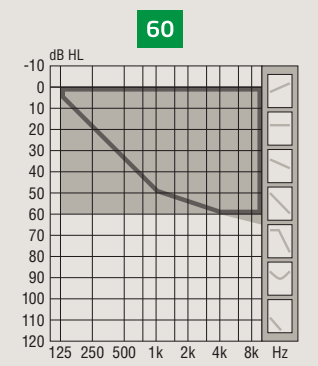

OSPL90 (peak)
 Ear simulator 116 dB SPL
 2cc coupler 106 dB SPL

Full-on gain (peak)
 Ear simulator 46 dB
 2cc coupler 36 dB

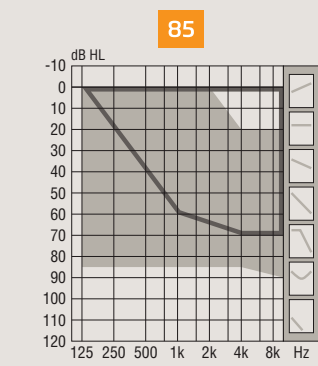

OSPL90 (peak)
 Ear simulator 127 dB SPL
 2cc coupler 117 dB SPL

Full-on gain (peak)
 Ear simulator 66 dB
 2cc coupler 55 dB

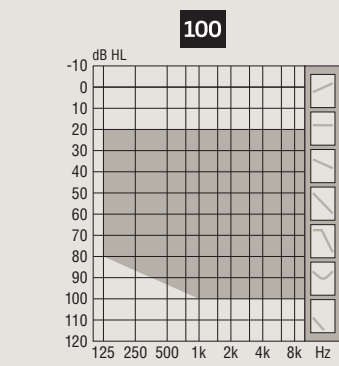

OSPL90 (peak)
 Ear simulator 132 dB SPL
 2cc coupler 124 dB SPL

Full-on gain (peak)
 Ear simulator 66 dB
 2cc coupler 57 dB

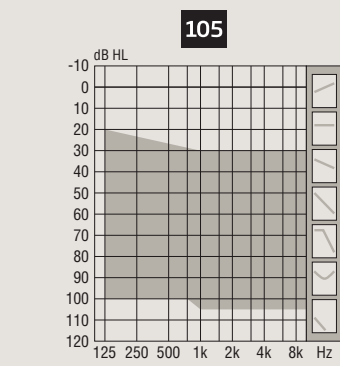

OSPL90 (peak)
 Ear simulator 135 dB SPL
 2cc coupler 127 dB SPL

Full-on gain (peak)
 Ear simulator 72 dB
 2cc coupler 64 dB

miniBTE

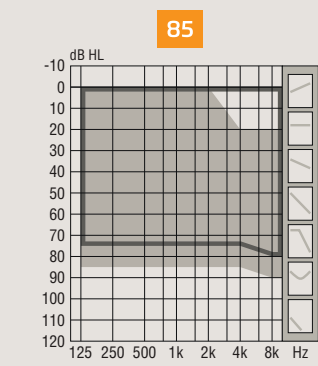

OSPL90 (peak)
 Ear simulator 132 dB SPL
 2cc coupler 123 dB SPL

Full-on gain (peak)
 Ear simulator 63 dB
 2cc coupler 54 dB

Oticon More colors

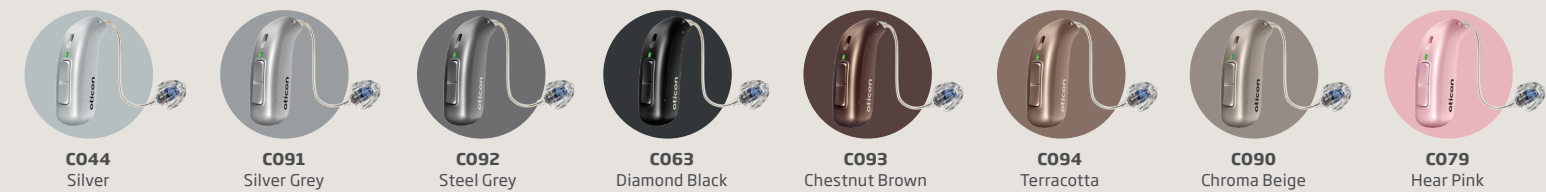

* Fitting range is based on Oticon More 1. Fitting range for Oticon More 2 & Oticon More 3 is limited to 8 kHz. Details available in Technical data sheets.

Hook and thin tube for miniBTE R and miniBTE T

Hook and Corda miniFit (thin tube) options

The miniBTE R and the miniBTE T are defaulted with a damped hook. The more discreet Corda miniFit 0.9 is also compatible with the miniBTE R and miniBTE T.

miniBTE hook



Accessories for hooks:
- Damper

Corda miniFit



Accessories for Corda miniFit:
- Length- 1-4
- Ear grip miniFit for Corda
- Measuring tool

Corda miniFit



Accessories for Corda miniFit:
- Length- 1-4
- Ear grip miniFit for Corda
- Measuring tool

Corda miniFit earpieces**

Standard earpieces

miniFit domes		5 mm+	6 mm	8 mm	10 mm	12 mm
OpenBass dome		•	•	•	•	•
Bass dome, double vent (1.4 mm)			•	•	•	•
Power dome			•	•	•	•

All domes:
- Are made of silicone
- Are compatible with Corda miniFit
- Have built-in wax protection

**For available retention styles, please refer to the RITE & Corda miniFit Earmold order form.
+5 mm OpenBass dome is equal in both appearance and audiology to 5 mm Open dome.

Grip Tip

Select between two different Grip Tip types, in two different sizes (small & large) for both left and right ear.

No vent
Vent

Grip Tip:
- Is more durable than domes
- Has a tacky texture to help prevent slippage

Customized earpieces*

MicroMold	
MicroMold, VarioTherm®	

MicroMold:
- Is made of acrylic
- Uses ProWax filter

VarioTherm®:
- Is thermoplastic
- Remains hard at room temperature for easy insertion
- Softens at body temperature for increased comfort and optimum sealing
- Available in two hardnesses – 50 and 70. 70 is standard.

Please note:
VarioTherm® requires gentle warming of the mold with a hair dryer before insertion or removal of the thin tube.

* Requires taking an ear impression.
© VarioTherm is a registered trademark of Dreve

Receivers, molds, and earpieces for miniRITE R and miniRITE T

miniFit receivers

Select between three different receivers.
 The 60 & 85 miniFit receivers are available with wire length 0-5.
 The 100 miniFit receiver is available with wire length 1-5.



Accessories for miniFit receivers:

- Ear grip miniFit for receiver 60
- Ear grip miniFit for receiver 85
- ProWax miniFit filter
- Measuring tool

MicroShells

Select between two MicroShell fitting levels.
 MicroShells have fixed wires in length 1-5.



Accessories for MicroShells:

- ProWax miniFit filter
- Measuring tool

Power Receiver Molds

Select between two Power Receiver Molds fitting levels. Power Receiver Molds have separate wires, available in length 1-5.



Accessories for Power Receiver Molds:

- ProWax filter
- Measuring tool

Standard earpieces

miniFit domes 5 mm* 6 mm 8 mm 10 mm 12 mm

OpenBass dome		60	60 85	60 85	60 85	60 85
Bass dome, double vent			60 85 100	60 85 100	60 85 100	60 85 100
Power dome			60 85 100	60 85 100	60 85 100	60 85 100

* 5 mm OpenBass dome is equal in both appearance and audiology to 5 mm Open dome.

OpenBass dome

This miniFit dome supports better audiology and streaming experience in the lower frequencies. Vent size is 4.5-5 mm to ensure a high-quality open sound experience.

miniFit domes characteristics:

- Compatible with miniFit receivers only
- Made of silicone
- Built-in wax protection

Grip Tip

Select between two different Grip Tip types, in two different sizes (small & large) for both left and right ear.



Grip Tip characteristics:

- More durable than domes
- Tacky texture to help prevent slippage

Customized earpieces*

LiteTip		60 85
MicroMold		60 85
MicroShell		60 85
Power Receiver Molds		100 105
LiteTip, VarioTherm®		60 85
MicroMold, VarioTherm®		60 85

* Requires taking an ear impression.

® VarioTherm is a registered trademark of Dreve

MicroMold, LiteTip, and Power Receiver Mold characteristics:

- Based on an ear impression
- Made of acrylic
- Use ProWax filter

MicroShell characteristics:

- Based on an ear impression
- Made of acrylic
- Has a fixed wire and speaker
- Uses ProWax miniFit filter

VarioTherm characteristics:

- Based on an ear impression
- Made of thermoplastic
- Remains hard at room temperature for easy insertion
- Softens at body temperature for increased comfort and optimum sealing
- Available in two hardnesses – shore 50 and shore 70. The harder (shore 70) is standard.

Please note:

VarioTherm earpieces require gentle warming with a hair dryer before insertion or removal of the receiver.

Connectivity & Accessories



Bluetooth® technology in hearing aids

Bluetooth technology enables devices to speak together and transfer data wirelessly – be it speech, commands, or other types of data.

Bluetooth can refer to two different wireless technologies: classic Bluetooth technology and Bluetooth® Low Energy technology. Bluetooth® Low Energy is the standard used in Oticon hearing aids – because it is a newer technology that consumes much less power than classic Bluetooth, thus ensuring a longer battery life for the hearing aids.

- Bluetooth® Low Energy is used in Apple mobile products such as the iPhone. Therefore, it is possible to stream sound directly from Apple iPhone, iPad or iPod touch® to Oticon hearing aids – be it phone calls, music, or any other audio.
- Android has recently launched its own protocol based on Bluetooth® Low Energy called Audio Streaming for Hearing Aids (ASHA). ASHA makes it possible for Android users to enjoy direct streaming of phone calls, music, or any other audio from an ASHA-compatible phone.
- Classic Bluetooth technology – still used by most Android devices – consumes much more power than Bluetooth® Low Energy, which is why most hearing aids do not support it.

To know more about the compatibility of Oticon More with smartphones, apps and connectivity products, consult oticon.com/support/compatibility

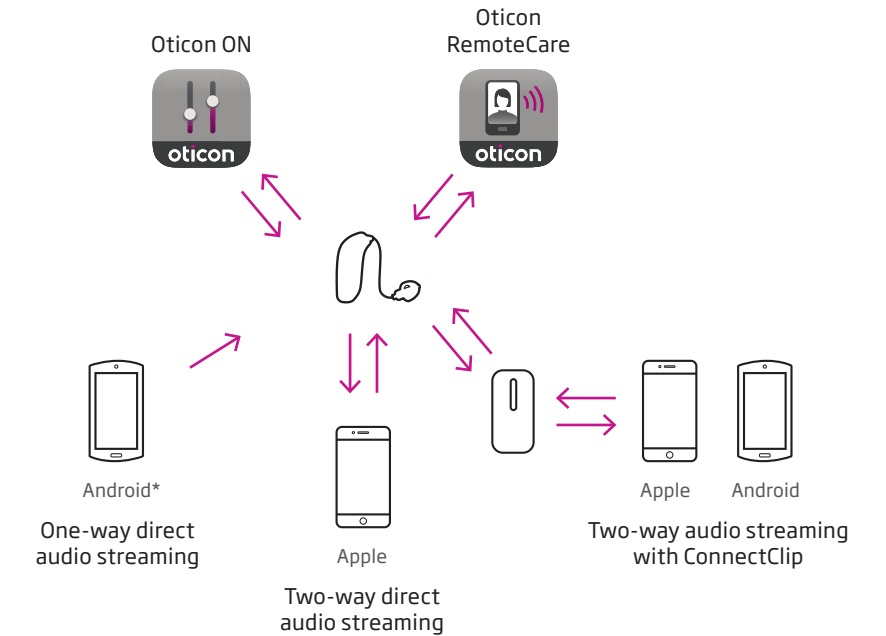

* One-way direct streaming from Android is only possible if the mobile device supports ASHA.



! DID YOU KNOW

Oticon More is a Made for iPhone® hearing aid and is also compatible with ASHA – meaning it can support direct streaming from iPhone, iPad, iPod touch and Android devices.*

Streaming directly from a mobile device

Oticon More offers an immersive streaming experience with excellent sound quality from mobile devices.

iPhone, iPad and iPod touch

Oticon More is a Made for iPhone® (MFi) hearing aid. It can directly connect to iPhone, iPad and iPod touch for streaming audio and thereby act as wireless stereo headphones – without the need for an intermediary device.

Android devices

Oticon More also supports Audio Streaming for Hearing Aids (ASHA) and can therefore stream audio directly from Android devices that also support ASHA. Users of devices that do not support ASHA should use ConnectClip as an intermediary device.



Oticon MyMusic – a dedicated program for music lovers

With Oticon MyMusic, the legendary sound quality of Oticon More overcomes one of the toughest challenges for hearing aids: making an outstanding music listening experience.

Co-created with music lovers who have different types of hearing loss, Oticon MyMusic is tailor-made to deliver excellent music performance, with music-oriented signal processing strategies such as an optimized compression scheme. This processing captures the complex dynamics of music much better than trying to apply ordinary speech processing strategies to music.* Consequently, people with hearing loss rated it 72% higher than the previous music program.**

With this new capability, we've taken an impressive step in improving the music listening experience for people with hearing loss.



* Brændgaard, M. (2021). The development behind Oticon MyMusic. Oticon techpaper.
** Man B.K.L., Garnæs M.F., Kjeldal R., Sørup Yssing M., Løve S (2021). Oticon MyMusic Clinical Evidence. Oticon Whitepaper.

Controlling hearing aids with Oticon ON

Oticon ON provides users with a discreet way to control their hearing aids. With the app, users can:

- Adjust the volume of their hearing aids independently and switch between listening programs, including Oticon MyMusic
- Keep an eye on their battery level
- Find their hearing aids if they lose them
- Suppress environmental noise using the MoreSound Booster function – whenever they need some extra help
- Fine-tune the sound when streaming music or a movie, for a personalized listening experience – thanks to the streaming equalizer feature
- Handle wireless accessories paired with their hearing aids – such as TV Adapter, EduMic or ConnectClip
- Set personal listening goals and track the progress of their daily hearing aid use through HearingFitness™



Enjoying remote fittings with Oticon RemoteCare

With Oticon RemoteCare, users can enjoy remote support from their hearing care professional in real time. When it's not possible or convenient for them to physically visit the clinic, they can get their hearing aids adjusted or receive counseling through an app on their mobile device – while the hearing care professional connects to their hearing aids through Oticon Genie 2.

Through the app, the user can have an audio or video conversation – or just chat – with their hearing care professional and get their hearing aids adjusted in real-time. Oticon RemoteCare also makes it possible to fine-tune the settings to fit a specific environment where a user might be struggling – be it at home with their spouse, at their workplace, or in a noisy restaurant setting.



Apple, the Apple logo, iPhone, iPad, and iPod touch are trademarks of Apple Inc., registered in the U.S. and other countries. App Store is a service mark of Apple Inc. Android, Google Play, and the Google Play logo are trademarks of Google LLC.

TELL YOUR CLIENT

Stream sound directly from iPhone, iPad, iPod touch and compatible Android devices to your Oticon More hearing aids.

TELL YOUR CLIENT

Change the program to Oticon MyMusic whenever you want to listen to live music or streamed music.

TELL YOUR CLIENT

Connect your smartphone to your hearing aids to control volume, switch programs, check battery level – and more – just with a tap of your finger.

TELL YOUR CLIENT

You can use this app to get your hearing aids adjusted or receive extra support whenever you need, from the comfort of your own home.

An extensive range of connectivity possibilities

Oticon More hearing aids can connect wirelessly to a wide range of devices:

- **Smartphones** – Enable music & audio streaming and use of Oticon ON for hearing aid control and Oticon RemoteCare for remote hearing aid adjustments
- **ConnectClip** – Transforms hearing aids into a wireless headset and also works as a remote microphone
- **TV Adapter**– Streams TV sound directly to hearing aids without affecting the TV volume level
- **Remote Control** – Helps people discreetly control their hearing aids
- **Phone Adapter** – Connects hearing aids to a landline phone, together with ConnectClip
- **EduMic** – Helps people overcome distance and noise, by acting as a remote microphone, a telecoil receiver, or a media streamer

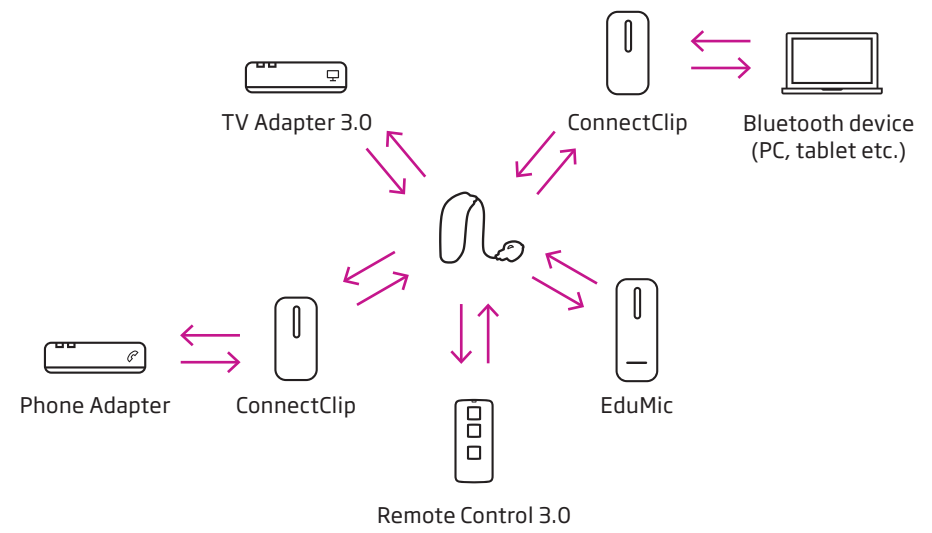

Calling hands-free with ConnectClip

From mobile devices

Oticon More hearing aids, used together with ConnectClip, allow for hands-free, two-way audio streaming of conversations from any device supporting classic Bluetooth technology. The hearing aids are transformed into a wireless headset and the user's voice is picked up by ConnectClip's built-in directional microphones.

From a landline

Phone Adapter 2.0, used together with ConnectClip, allows for hands-free, two-way audio streaming of conversations between a landline and the hearing aids.

Streaming from a computer or tablet with ConnectClip

Using ConnectClip, users can stream any sound wirelessly from their computer to their hearing aids – for instance music or an audiobook. They can also have video conversations as their voice is streamed back to the computer using ConnectClip's microphone.

For computers without Bluetooth technology, a USB Bluetooth adapter (such as Sennheiser BTD 800) will be needed to pair with ConnectClip.

Streaming from a TV with TV Adapter 3.0

TV Adapter 3.0 enables users of Oticon More to wirelessly stream the sound from their TV or home entertainment system directly to their hearing aids. Users can set the volume to their preferred level – while keeping the TV volume comfortable for others in the room – and enjoy a quality listening experience free from the distraction of surrounding noise.

TV Adapter 3.0 offers multiple options to connect to TVs and other audio sources.

TV Adapter 3.0 can simultaneously stream to as many Oticon hearing aids as needed. Users of Oticon More hearing aids can pair with up to 4 TV Adapters and use the Oticon ON app to select the one they wish to stream sound from.



TELL YOUR CLIENT
Expand the benefits of your hearing aids using Oticon connectivity devices.

TELL YOUR CLIENT
Enjoy comfortable hands-free calls using ConnectClip.

TELL YOUR CLIENT
Stream video conversations between your computer and your hearing aids.

TELL YOUR CLIENT
Listen to your TV at the volume that you prefer, while keeping it comfortable for your family.

Streaming from a hearing loop system



Oticon More features a telecoil and can stream audio from hearing loop systems without any additional device.

Making the most of education with EduMic

EduMic enables users to transmit their teacher's voice clearly and directly to their hearing aids. It has been shown to improve speech understanding in noisy and reverberant environments, for an enhanced learning experience.

EduMic streams sound from numerous media outlets directly to hearing aids. It also connects to existing FM classroom systems.

Hearing from a distance with ConnectClip or EduMic

Oticon ConnectClip and EduMic are both remote microphones that can stream another person's voice directly to Oticon More hearing aids. They can help the user hear what's important, even in crowded and noisy environments or when the speaker is some distance away.

Using the Oticon ON app, users can also adjust environmental noise to focus more easily on their conversation partner.

Controlling hearing aids with Remote Control 3.0

Remote Control 3.0 is a small device that gives users discreet control over their Oticon hearing aids. It makes it possible to easily adjust volume, switch between programs, or mute the hearing aids without touching them. Remote Control 3.0 is especially beneficial for users with dexterity challenges or for people in need of a discreet way to control their hearing aids in social situations.



TELL YOUR CLIENT
Get access to sound from hearing loop systems in public places such as theaters, museums, lecture halls, or cinemas.



TELL YOUR CLIENT
Transmit your teacher's voice directly to your hearing aids to overcome distance and noise.



TELL YOUR CLIENT
Hear the voice of your conversation partner clearly, directly in your hearing aids, even at a distance or in noisy environments.

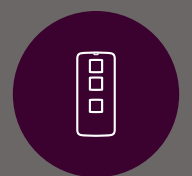

TELL YOUR CLIENT
Control your hearing aids easily using a small and discreet device.

life-changing
technology

21-246863 1555-8562/08.22



[oticon.com](https://www.oticon.com)

Oticon is part of the Demant Group.

oticon
life-changing **technology**