

Alta2 | Nera2 | Ria2

## INSTRUCTIONS FOR USE

RITE



Alta2, Alta, Nera2, Nera, Ria2, Ria

**oticon**  
PEOPLE FIRST

## Introduction to this booklet

This booklet guides you in how to use and maintain your new hearing instrument. Please read the booklet carefully including the **Warning section**. This will help you to achieve the full benefit of your new hearing instrument.

Your Hearing Care Professional has adjusted the hearing instrument to meet your needs. If you have additional questions, please contact your Hearing Care Professional.

| **About** | [Start up](#) | [Handling](#) | [Options](#) | [Warnings](#) | [Additional](#)s |

For your convenience this booklet contains a navigation bar to help you navigate easily through the different sections.

## Indication for use

The hearing instrument is intended to amplify and transmit sound to the ear and thereby compensate for mild to moderate-to-severe-to-profound hearing impairment.

### IMPORTANT NOTICE

The hearing instrument amplification is uniquely adjusted and optimized to your personal hearing capabilities during the instrument fitting performed by your Hearing Care Professional.

## Table of contents

|                 |  |    |
|-----------------|--|----|
| <b>About</b>    | Identify your hearing instrument speaker and ear piece | 6  |
|                 | RITE   | 8  |
|                 | Identify left and right instrument                     | 10 |
|                 | Battery  | 11 |
| <b>Start up</b> | Turn the hearing instrument ON and OFF                 | 12 |
|                 | When to replace a battery                              | 13 |
|                 | Replace the battery                                    | 14 |
| <b>Handling</b> | Caring for your hearing instrument                     | 16 |
|                 | Put on the instrument                                  | 18 |
|                 | Speaker with dome or GripTip                           | 20 |
|                 | Replace dome or GripTip                                | 21 |
|                 | Speaker with micro mold, LiteTip or power mold         | 22 |
|                 | Maintain the micro mold, LiteTip or power mold         | 23 |

|                   |  |    |
|-------------------|--|----|
| <b>Options</b>    | Optional features and accessories          | 24 |
|                   | Mute the hearing instrument (optional)     | 25 |
|                   | Change programs (optional)                 | 26 |
|                   | Change volume (optional)                   | 28 |
|                   | Tamper-resistant battery drawer (optional) | 30 |
|                   | Wireless accessories (optional)            | 32 |
|                   | Other options (optional)                   | 34 |
| <b>Warnings</b>   | Warnings                                   | 36 |
| <b>Additional</b> | Troubleshooting guide                      | 46 |
|                   | Water resistant                            | 48 |
|                   | Warranty certificate                       | 50 |
|                   | International warranty                     | 51 |
|                   | Mobile phone                               | 52 |
|                   | Technical information                      | 54 |

## Identify your hearing instrument speaker and ear piece

This will make it easier for you to navigate through this booklet.

A RITE comes with different speakers and ear pieces.

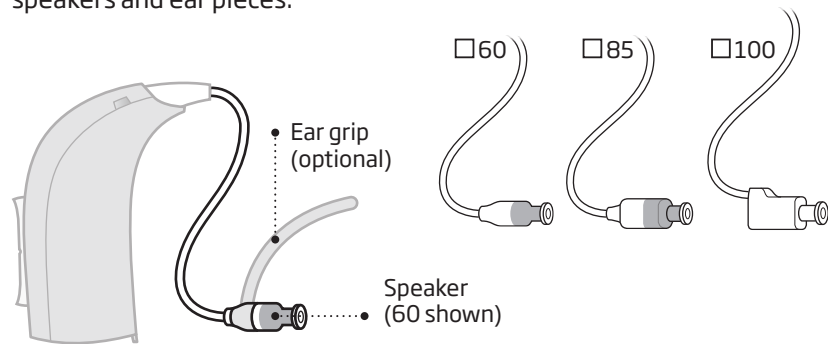

- RITE speaker**  
A RITE will have one of the following speakers.

- RITE ear pieces**  
A RITE will have one of the following ear pieces.

- RITE with Power mold speaker**



Dome (open dome shown)



GripTip



Micro mold or LiteTip



## RITE

### What it is

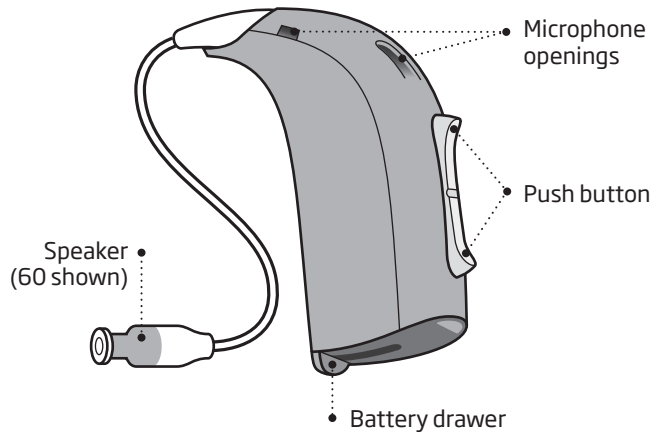

### What it does

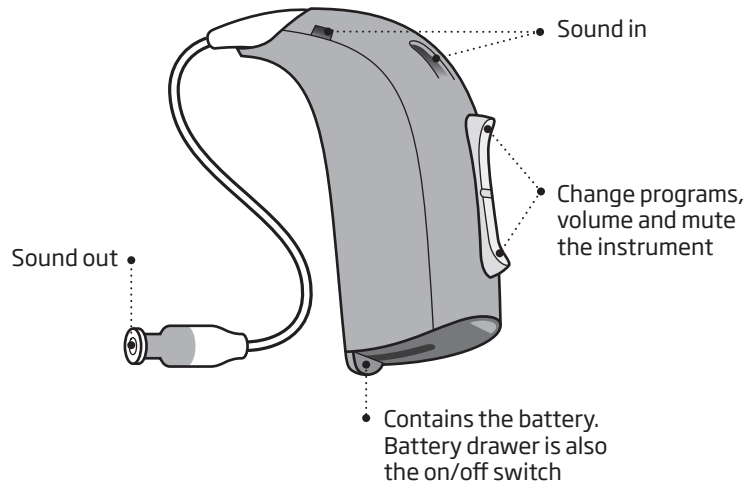

## Identify left and right instrument

It is important to distinguish between the left and the right instrument as they might be programmed differently. You can find left/right color indicators inside the battery drawer or on 60 and 85 speakers or on the micro molds/LiteTip.

A **RED** indicator marks the **RIGHT** instrument.

A **BLUE** indicator marks the **LEFT** instrument.

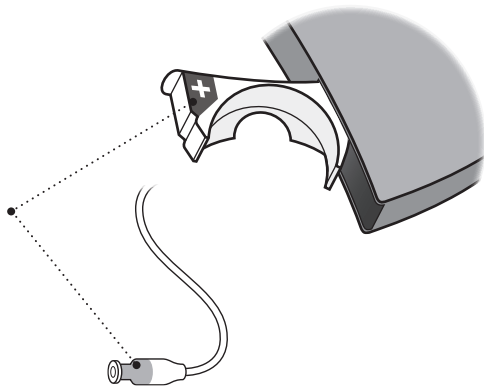

## Battery

Your hearing instrument is a miniature electronic device that runs on special batteries. To activate the hearing instrument, you must insert a new battery in the battery drawer. See how in the “Replace the battery” section.

Battery drawer

Your instrument battery size is 312

Pull out to open

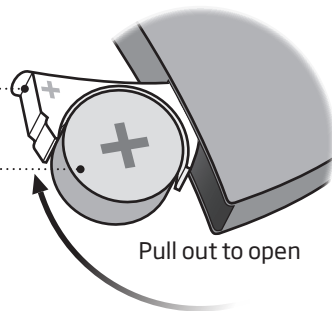

## Turn the hearing instrument ON and OFF

The battery drawer is also used to switch the hearing instrument on and off. To preserve the battery, make sure your instrument is switched off when you are not wearing it.

**Turn ON**  
Close the battery drawer with the battery in place.

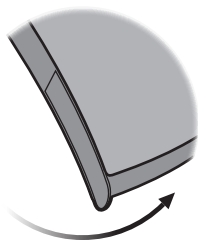

**Turn OFF**  
Open the battery drawer.

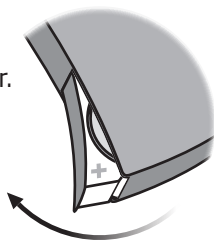

## When to replace a battery

When it is time to replace the battery you will hear two beeps repeated in moderate intervals until the battery runs out.



**Two beeps**  
= The battery is running low



**Four beeps**  
= The battery has run out

### Battery maintenance tip

To make sure the hearing instrument is always working, bring spare batteries with you, or replace the battery before you leave home.

## Replace the battery

### 1. Remove

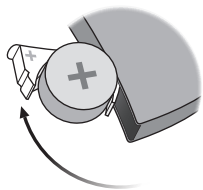

Fully open the battery drawer. Remove the battery.

### 2. Uncover

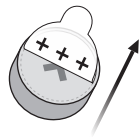

Remove the sticky label from the + side of the new battery.

### 3. Insert

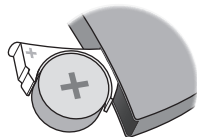

Insert the new battery into the battery drawer. Make sure the + side faces up.

### 4. Close

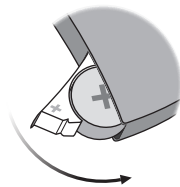

Close the battery drawer. The instrument will play a jingle through the ear piece. Hold the earpiece close to your ear to hear the jingle.

### Tip

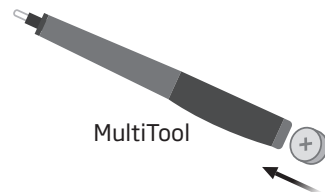

The MultiTool can be used for battery change. Use the magnetic end to remove and insert batteries.

The MultiTool is provided by your Hearing Care Professional.



## Caring for your hearing instrument

When handling your hearing instrument, hold it over a soft surface to avoid damage if you drop it.

### Clean the microphone openings

Carefully brush away debris from the openings. Gently brush the surface. Make sure the brush is clean and that it is not pressed into the openings.

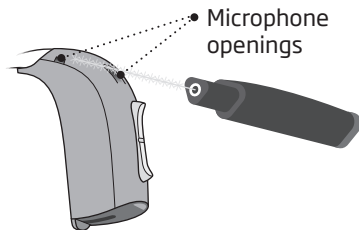

### IMPORTANT NOTICE

Use a soft, dry cloth to clean the hearing instrument. It must never be washed or immersed in water or other liquids.

## The MultiTool

The MultiTool contains a brush and a wire loop for cleaning ear wax from the mold. The brush can be replaced and purchased from your Hearing Care Professional.

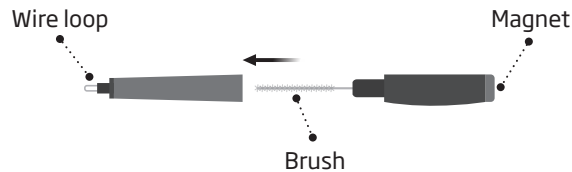

## Put on the instrument

The speaker brings the sound into your ear. The speaker should always be used with an ear piece attached. Use only parts designed for your hearing instrument.

If the speaker has an ear grip, place it in the ear so it follows the contour of the ear (see Step 3).

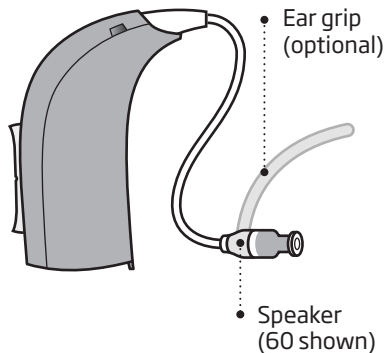

### Step 1



Place the hearing instrument behind your ear.

### Step 2

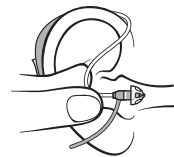

Hold the bend of the speaker wire between your thumb and index finger. The ear piece should point towards the ear canal opening.

### Step 3



Gently push the ear piece into your ear canal until the speaker wire sits close against the side of your head.

## Speaker with dome or GripTip

The dome and Grip Tip are made from soft, medically approved rubber material. There are 4 different types of domes. Check your dome type and size below.

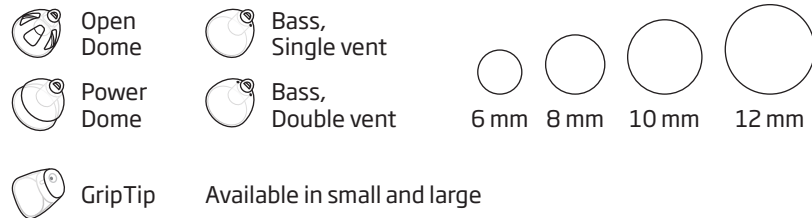

### IMPORTANT NOTICE

If the dome is not on the speaker when removed from the ear, the dome might still be in the ear canal. Consult your Hearing Care Professional for further instructions.

## Replace dome or GripTip

The dome or GripTip should not be cleaned. When it is more or less filled with wax, replace it with a new one.

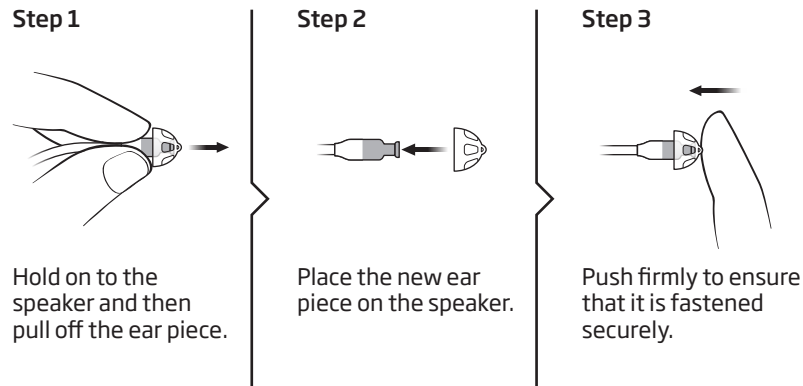

## Speaker with micro mold, LiteTip or power mold

There are 3 different types of molds: micro mold, LiteTip and power mold. The molds are customized for your ear shape.



• Micro mold



• LiteTip



• Power mold

## Maintain the micro mold, LiteTip or power mold

The mold should be cleaned regularly.

The wax filter in the ear piece should be replaced when clogged or when the hearing instrument does not sound normal.

Use the wax filter delivered by your Hearing Care Professional.

*The vent is cleaned by pressing the brush through the hole, twisting it slightly.*

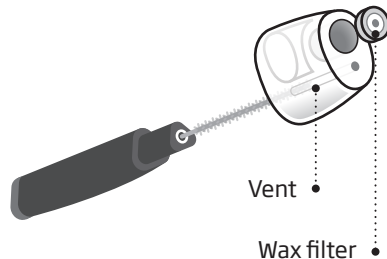

## Optional features and accessories

The features and accessories described on the following pages are optional. Please contact your Hearing Care Professional to find out how your hearing instrument is programmed.

If you experience difficult listening situations, a special program may be helpful. These are programmed by your Hearing Care Professional.

*Write down hearing situations where you may need help.*

---

---

---

### Mute the hearing instrument (optional)

Use the mute function if you need to silence the instrument while wearing it.

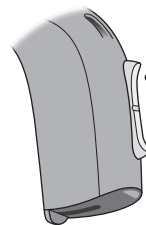

Apply a very long press to either end of the button to mute the instrument. To reactivate the instrument, push the button briefly.

#### **IMPORTANT NOTICE**

Do not use the mute function as an off switch, as the hearing instrument still draws current from the battery in this mode.

## **Change programs** (optional)



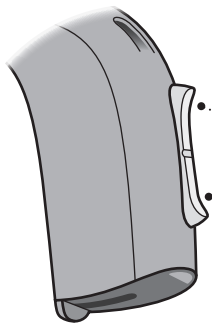

Your hearing instrument can have up to 4 different programs. These are programmed by your Hearing Care Professional.



Press up or down between programs

Note that you can change continuously between programs - both up and down in the program order. If for example you want to go from program 1 to 4, you can press the down button once instead of pressing the up button 3 times.

## To be filled out by the Hearing Care Professional

| Program | Sound you will hear when activated  | When to use |
|---------|---|-------------|
| 1       |  "1 beep"  |             |
| 2       |  "2 beeps" |             |
| 3       |  "3 beeps" |             |
| 4       |  "4 beeps" |             |

Program change:

LEFT

RIGHT

Short press

Long press

## **Change volume** (optional)

The push button allows you to adjust the volume.  
You will hear a click when you turn up or down the volume.



### To be filled out by the Hearing Care Professional

|               |                               |                                |                                      |
|---------------|-------------------------------|--------------------------------|--------------------------------------|
| Volume change | <input type="checkbox"/> LEFT | <input type="checkbox"/> RIGHT | <input type="checkbox"/> Short press |
|---------------|-------------------------------|--------------------------------|--------------------------------------|

## **Quick reset**

If you wish to return to the standard settings of the instrument programmed by your Hearing Care Professional, simply open and then close the battery drawer.

### Open

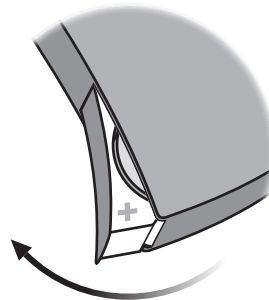

### Close

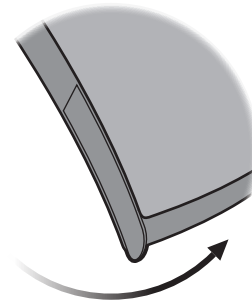

## ☐ **Tamper-resistant battery drawer** (optional)

To keep the battery out of reach of infants, small children and people with learning difficulties, a tamper-resistant battery drawer should be used. Use a small screwdriver to open the drawer.

### **IMPORTANT NOTICE**

Avoid using excessive force to open the battery drawer. Do not force the battery drawer beyond its fully opened position. Make sure to insert the battery correctly.

Please contact your Hearing Care Professional if you suspect the tamper-resistant effectiveness and locking ability is damaged.

### **Unlock the battery drawer**

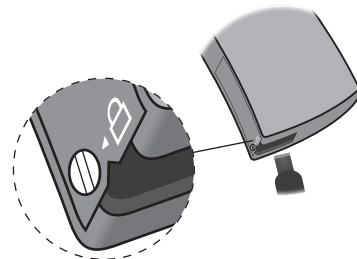

Use the screwdriver to turn the screw to unlock position (vertical). Insert the screwdriver into the slit in the bottom of the hearing instrument and push the door open.

### **Lock the battery drawer**

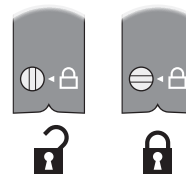

Make sure the drawer is completely closed. Turn the screw to the locked position (horizontal).



## **Wireless accessories** (optional)

As an enhancement to your wireless hearing instrument a broad range of wireless accessories are available.

### **ConnectLine**

ConnectLine is a family of products that allows you to receive audio signals from TVs, phones, music players, PCs or an external microphone wirelessly through your hearing instrument.

### **Remote Control**

The Remote Control offers an opportunity to change program or adjust the volume in your hearing instrument.

### **FM**

Your hearing instrument supports the option of attaching an FM system. The FM system allows you to receive speech or audio signals directly to your hearing instrument from a dedicated transmitter.

For detailed information on wireless accessories contact your Hearing Care Professional or visit **[www.oticonusa.com](http://www.oticonusa.com)**.

## □ **Other options** (optional)



### **Telecoil**

Telecoil helps you hear better when using a telephone with a built in loop or when you are in buildings with teleloop systems such as theaters, churches or lecture rooms. This symbol or a similar sign is shown wherever a teleloop has been installed.



### **Autophone**

is a program that can be automatically activated if your telephone has a built in teleloop (see above). A magnet may need to be placed on your telephone next to the sound outlet.

### **Direct Audio Input (DAI)**

allows your hearing instrument to receive signals directly from external sources such as TV, radio, music players, etc. The DAI adaptor is mounted to your instrument and via a cable connected to an external sound source.

For more information on these options contact your Hearing Care Professional.

#### **IMPORTANT NOTICE**

When the DAI is connected to an audio source plugged into a wall outlet, the audio source must comply with IEC-60065, IEC-60601 or equivalent safety standards.

## Warnings

You should familiarize yourself fully with the following general warnings before using your hearing instrument for personal safety and to secure correct use.

Consult your Hearing Care Professional if you experience unexpected operations or events with your hearing instrument.

### Usage of hearing instruments

- Hearing instruments should be used only as directed and adjusted by your Hearing Care Professional. Misuse can result in sudden and permanent hearing loss.

- Never allow others to wear your hearing instrument as incorrect usage could cause permanent damage to their hearing.

### Choking hazards & risk of swallowing batteries

- Hearing instruments, their parts, and batteries should be kept out of reach of children and anyone who might swallow these items, or otherwise cause injury to themselves.

- Batteries have occasionally been mistaken for pills. Therefore check your medicine carefully before swallowing any pills.
- Most hearing instruments can be supplied with a tamper-resistant battery drawer upon request. This is strongly recommended for infants, small children, and people with learning difficulties.
- Children below 36 months must always use a tamper-resistant battery drawer. This option is available in BTE, miniBTE, RITE and miniRITE instruments.

*If a battery or hearing instrument is swallowed, see a doctor immediately and contact the National Poison Center at 1-800-222-1222 or National Battery Ingestion Hotline at 202-625-3333.*

### Battery use

- Always use batteries recommended by your Hearing Care Professional. Batteries of low quality may leak and cause bodily harm.
- Never attempt to recharge your batteries and never dispose of batteries by burning them. There is a risk that the batteries will explode.

## Warnings

### Dysfunction

- Be aware of the possibility that your hearing instrument may stop working without notice. Keep this in mind when you depend on warning sounds (e.g., when you are in traffic). The hearing instruments may stop functioning, for instance if the batteries have expired or if the tubing is blocked by moisture or ear wax.

### Active implants

- Caution must be taken with active implants. In general, follow the guidelines recommended by manufacturers of implantable defibrillators and pacemakers regarding use with mobile phones.
- If you wear an active implant, then keep the hearing instrument more than 15 cm away from the implant. If you have an Autophone magnet or MultiTool (which has a built-in magnet), keep them more than 30 cm away from the implant. E.g., do not carry them in a breast pocket.

- If you have an active brain implant, please contact the manufacturer of your implantable device for information about the risk of disturbance.

### Explosives

- The power source in your hearing instrument has insufficient energy to cause fire in normal usage conditions. The hearing instrument has not been tested for compliance with international standards concerning explosive environments. It is recommended not to use your hearing instrument in areas where there is a danger of explosions.

### X-ray, CT, MR, PET scanning and electrotherapy

- Remove your hearing instrument for example during X-ray, CT / MR / PET scanning electrotherapy or surgery as your hearing instrument may be damaged when exposed to strong fields.

## Warnings

### Avoiding heat and chemicals

- Your hearing instrument must never be exposed to extreme heat e.g., left inside a parked car in the sun.
- Your hearing instrument must not be dried in microwave ovens or other ovens.
- The chemicals in cosmetics, hairspray, perfume, after shave lotion, suntan lotion and insect repellent can damage your hearing instrument. Always remove your hearing instrument before applying such products and allow time to dry before putting it on.

### Power instrument

- Special care should be exercised in selecting, fitting and using a hearing instrument where maximum sound pressure capability exceeds 132 dB SPL (IEC 711), as there may be risk of impairing the remaining hearing of the hearing instrument user.

*For information on whether your instrument is a power instrument, speak with your Hearing Care Professional or consult the settings overview page at the end of this manual.*

### Possible side effects

- Hearing instruments, molds or domes may cause an accelerated accumulation of ear wax.
- The otherwise non-allergenic materials used in hearing instruments may in rare cases cause a skin irritation or any other unusual condition.

*Please seek consultation with a physician if these conditions occur.*

### Interference

- Your hearing instrument has been thoroughly tested for interference, according to the most stringent international standards. However, interference with your hearing instrument and other devices may occur, (e.g., some mobile telephones, citizens band systems and shop alarm systems). If this occurs, increase the distance between the hearing instrument and the device.

## Warnings

### Warning to hearing instrument dispensers

A hearing instrument dispenser should advise a prospective hearing instrument user to consult immediately with a licensed physician (preferably an ear specialist) before dispensing a hearing instrument if the hearing instrument dispenser determines through inquiry, actual observation, or review of any other available information concerning the prospective user, that the prospective user has any of the following conditions:

- (i) Visible congenital or traumatic deformity of the ear.
- (ii) History of active drainage from the ear within the previous 90 days.

- (iii) History of sudden or rapidly progressive hearing loss within the previous 90 days.
- (iv) Acute or chronic dizziness.
- (v) Unilateral hearing loss of sudden or recent onset within the previous 90 days.
- (vi) Audiometric air-bone gap equal to or greater than 15 decibels at 500 Hertz (Hz), 1,000 Hz, and 2,000 Hz.
- (vii) Visible evidence of significant cerumen accumulation or a foreign body in the ear canal.
- (viii) Pain or discomfort in the ear.

Special care should be exercised in selecting and fitting a hearing instrument whose maximum sound pressure capability exceeds 132 dB SPL as there may be risk of impairing the remaining hearing of the hearing instrument user.

### Important notice for prospective hearing instrument users

- Good health practice requires that a person with a hearing loss have a medical evaluation by a licensed physician (preferably a physician who specializes in diseases of the ear) before purchasing a hearing instrument. Licensed physicians who specialize in diseases of the ear are often referred to as

Otolaryngologists, Otologists or Otorhinolaryngologists. The purpose of medical evaluation is to ensure that all medically treatable conditions that may affect hearing are identified and treated before the hearing instrument is purchased. Following the medical evaluation, the physician will give you a written statement that states that your hearing loss has been medically evaluated and that you may be considered a candidate for a hearing instrument. The physician will refer you to an audiologist or a hearing instrument dispenser, as appropriate, for a hearing instrument evaluation.

## Warnings

- The audiologist or hearing instrument dispenser will conduct a hearing instrument evaluation to assess your ability to hear with and without a hearing instrument. The hearing instrument evaluation will enable the audiologist or dispenser to select and fit a hearing instrument to your individual needs. If you have reservations about your ability to adapt to amplification, you should inquire about the availability of a trial, rental or purchase-option program. Many hearing instrument dispensers now offer programs that permit you to wear a hearing instrument for a period of time for a nominal fee, after which you may decide if you want to purchase the hearing instrument. Federal law limits the sale of hearing instruments to those individuals who have obtained a medical evaluation from a licensed physician.
- Federal law permits a fully informed adult to sign a waiver statement declining the medical evaluation for religious or personal beliefs that preclude consultation with a physician. The exercise of such a waiver is not in your best health interest and its use is strongly discouraged. A hearing instrument will not restore normal hearing and will not prevent or improve a hearing impairment resulting from organic conditions. A hearing instrument is

only part of hearing rehabilitation and may need to be supplemented by auditory training and lip reading.

### **Children with hearing loss**

In addition to seeing a physician for medical evaluation, a child with a hearing loss should be directed to an audiologist for evaluation and rehabilitation, since hearing loss may cause problems in language development and educational and social growth of a child. An audiologist is qualified by training and experience to assist in the evaluation and rehabilitation of a child with a hearing loss. If the user is an infant, small child, or person of mental incapacity, it is recommended that the hearing instrument be modified with a tamper-resistant battery compartment.

## Troubleshooting guide

| Symptom                       | Possible causes  | Solutions                                |
|-------------------------------|--|--|
| No sound                      | Worn-out battery   | Replace the battery                      |
|                               | Clogged tube or earpieces (mold, dome, GripTip, micro mold or LiteTip) | Clean mold                               |
|                               |  | Consider replacing wax filter or dome    |
| Intermittent or reduced sound | Clogged sound outlet   | Clean mold or replace wax filter or dome |
|                               | Moisture   | Wipe battery with a dry cloth            |
|                               | Worn-out battery   | Replace the battery                      |
| Squealing noise               | Hearing instrument earpiece inserted incorrectly                       | Re-insert hearing instrument             |
|                               | Ear wax accumulated in ear canal                                       | Have ear canal examined by your doctor   |

If none of the above solutions work, consult your Hearing Care Professional for assistance.



## Water resistant

Your hearing instrument is water resistant which means it is designed to be worn in all daily life situations. Therefore you do not have to worry about sweat or getting wet in the rain. Should your hearing instrument come in contact with water and stop working, please follow these guidelines:

1. Gently wipe off any water
2. Open the battery drawer and remove the battery and gently wipe off any water in the battery drawer
3. Let the hearing instrument dry with the battery drawer left open for approximately 30 minutes
4. Insert a new battery

### IMPORTANT NOTICE

Do not wear your hearing instrument while showering or participating in water activities. Do not immerse your hearing instrument in water or other liquids.

## Warranty certificate

Name of owner: \_\_\_\_\_

Dispenser: \_\_\_\_\_

Dispenser address: \_\_\_\_\_

Dispenser phone: \_\_\_\_\_

Purchase date: \_\_\_\_\_

Warranty period: \_\_\_\_\_ Month: \_\_\_\_\_

Model left: \_\_\_\_\_ Serial no.: \_\_\_\_\_

Model right: \_\_\_\_\_ Serial no.: \_\_\_\_\_

Battery size: \_\_\_\_\_

## International warranty

Your hearing instrument is covered by an international limited warranty issued by the manufacturer for a period of 12 months from the date of delivery. This limited warranty covers manufacturing and material defects in the hearing instrument itself, but not accessories such as batteries, tubing, ear wax filters, etc. Problems arising from improper handling or care, excessive use, accidents, repairs made by an unauthorized party, exposure to corrosive conditions, physical changes in your ear, damage due to foreign objects entering the device, or incorrect adjustments are NOT covered by the limited warranty and may void it. The above warranty does not affect any legal rights that you

might have under applicable national legislation governing sale of consumer goods. Your Hearing Care Professional may have issued a warranty that goes beyond the clauses of this limited warranty. Please consult him/her for further information.

### **If you need service**

Take your hearing instrument to your Hearing Care Professional, who may be able to sort out minor problems and adjustments immediately.

## Mobile phone

Some hearing instrument users have reported a buzzing sound in their hearing instrument when they are using mobile phones, indicating that the mobile phone and hearing instrument may not be compatible. According to the ANSI C63.19 standard (ANSI C63.19-2007 American National Standard Methods of Measurement of Compatibility Between Wireless Communications Devices and Hearing Aids), the compatibility of a particular hearing instrument and mobile phone can be predicted by adding the rating for the hearing instrument immunity to the rating for the mobile phone emissions. For example, the sum of a hearing instrument rating of 2 (M2/

T2) and a telephone rating of 3 (M3/T3) would result in a combined rating of 5. Any combined rating that equals at least 5 would provide "normal use"; a combined rating of 6 or greater would indicate "excellent performance".

The immunity of this hearing instrument depend on the type of speakers:

|           | M  | T  |
|-----------|----|----|
| RITE 60   | M2 | T4 |
| RITE 85   | M4 | T4 |
| RITE 100  | M3 | T4 |
| RITE 105* | M2 | T4 |

\* Alta2, Nera2, Ria2

The equipment performance measurements, categories, and system classifications are based upon the best information available, but cannot guarantee that all users will be satisfied.

### IMPORTANT NOTICE

The performance of individual hearing instruments may vary with individual mobile phones. Therefore, please try this hearing instrument with your mobile phone or, if you are purchasing a new phone, be sure to try it with your hearing instrument prior to purchase.

For additional guidance, please ask your mobile phone provider for the booklet entitled "Hearing Aid Compatibility with Digital Wireless Mobile Phones."

## Technical information

The hearing instrument contains a radio transmitter using short range magnetic induction technology working at 3.84 MHz. The magnetic field strength of the transmitter is < -42 dB $\mu$ A/m @ 10m.

The emission power from the radio system is well below international emission limits for human exposure. For comparison, the radiation of the hearing instrument is lower than unintended electromagnetic radiation from, for example, halogen lamps, computer monitors, dishwashers, etc. The hearing instrument complies with international standards concerning Electromagnetic Compatibility.

Due to the limited space available on the instruments, all relevant approval markings are found in this document.

The hearing instrument contains a module with:

FCC ID: U28FU2BTERIT  
IC: 1350B-FU2BTERIT

The device complies with Part 15 of the FCC rules and RSS-210 of Industry Canada.

Operation is subject to the following two conditions:

1. This device may not cause harmful interference.
2. This device must accept any interference received, including interference that may cause undesired operation.

Changes or modifications not expressly approved by the party responsible for compliance could void the user's authority to operate the equipment.

More information: [www.oticon.com](http://www.oticon.com)

Oticon declares that this hearing instrument is in compliance with the essential requirements and other relevant provisions of Directive 1999/5/EC.

Declaration of conformity is available at:

Oticon A/S  
Kongebakken 9  
DK-2765 Smørum  
Denmark  
www.oticon.com

CE 0543 0682



Waste from electronic equipment must be handled according to local regulations.



N1175

IP58

| Power instrument <input type="checkbox"/> Yes <input type="checkbox"/> No |                              |                             |                              |                              |
|---|------------------------------|-----------------------------|------------------------------|------------------------------|
| Settings overview for your hearing instrument                             |                              |                             |                              |                              |
| Left  |                              |                             | Right                        |                              |
| <input type="checkbox"/> Yes  | <input type="checkbox"/> No  | Volume control              | <input type="checkbox"/> Yes | <input type="checkbox"/> No  |
| <input type="checkbox"/> Yes  | <input type="checkbox"/> No  | Program shift               | <input type="checkbox"/> Yes | <input type="checkbox"/> No  |
| <input type="checkbox"/> Yes  | <input type="checkbox"/> No  | Mute                        | <input type="checkbox"/> Yes | <input type="checkbox"/> No  |
| Volume control indicators   |                              |                             |                              |                              |
| <input type="checkbox"/> On   | <input type="checkbox"/> Off | Beeps at min /max volume    | <input type="checkbox"/> On  | <input type="checkbox"/> Off |
| <input type="checkbox"/> On   | <input type="checkbox"/> Off | Clicks when changing volume | <input type="checkbox"/> On  | <input type="checkbox"/> Off |
| <input type="checkbox"/> On   | <input type="checkbox"/> Off | Beeps at preferred volume   | <input type="checkbox"/> On  | <input type="checkbox"/> Off |
| Battery indicators  |                              |                             |                              |                              |
| <input type="checkbox"/> On   | <input type="checkbox"/> Off | Low battery warning         | <input type="checkbox"/> On  | <input type="checkbox"/> Off |

**TECHNICAL DATA**

**RITE**

Alta2

**oticon**  
PEOPLE FIRST

Measurements according to American National Standard ANSI S 3.22 (2003) and S3.7 (1995).

Supply voltage: Battery Zinc Air 1.4 Volt

0 dB SPL ref. 20 µPa

**RITE 60**

**60**

|   |              |
|---|--------------|
| Peak OSPL90                             | 105 dB SPL   |
| HF Average OSPL90                       | 103 dB SPL   |
| Peak Full-on Gain                       | 35 dB        |
| HF Average Full-on Gain                 | 30 dB        |
| Reference Test Gain                     | 26 dB        |
| Frequency Range                         | 100-8300 Hz  |
| Total Harmonic Distortion 500 Hz        | <2%          |
| Total Harmonic Distortion 800 Hz        | <2%          |
| Total Harmonic Distortion 1600 Hz       | <2%          |
| Battery Consumption                     | 1.3 mA       |
| Equivalent Input Noise Level (omni/dir) | 16/24 dB SPL |
| HF Average SPLITS (left/right ear)      | 82/82 dB SPL |
| Attack Time                             | 1 ms         |
| Release Time                            | 120 ms       |

**RITE 85**

**85**

|              |                |                |
|--------------|----------------|----------------|
| 118 dB SPL   | 124 dB SPL     | 125 dB SPL     |
| 114 dB SPL   | 121 dB SPL     | 121 dB SPL     |
| 55 dB        | 57 dB          | 61 dB          |
| 47 dB        | 52 dB          | 56 dB          |
| 38 dB        | 44 dB          | 44 dB          |
| 100-8700 Hz  | 100-8100 Hz    | 100-7800 Hz    |
| <2%          | <2%            | <2%            |
| <2%          | <2%            | <2%            |
| <2%          | <2%            | <2%            |
| 1.2 mA       | 1.3 mA         | 1.3 mA         |
| 18/25 dB SPL | 16/25 dB SPL   | 16/28 dB SPL   |
| 95/95 dB SPL | 101/101 dB SPL | 109/109 dB SPL |
| 1 ms         | 1 ms           | 1 ms           |
| 60 ms        | 30 ms          | 123 ms         |

**RITE 100**

**100**

**RITE 105**

**105**

## OSPL90 - Output Sound Pressure Level

Input: 90 dB SPL.  
Technical setting: A0

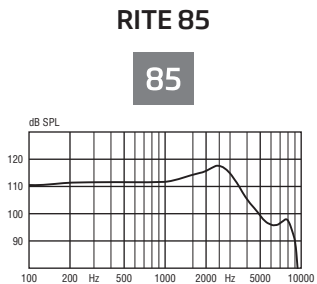
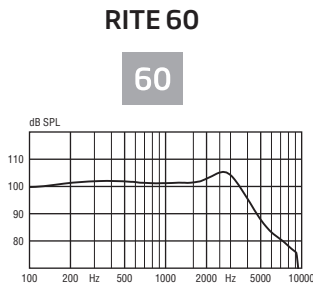

## OSPL90 - Output Sound Pressure Level

Input: 90 dB SPL.  
Technical setting: A0

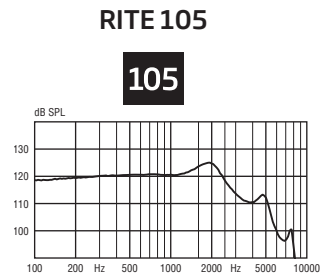
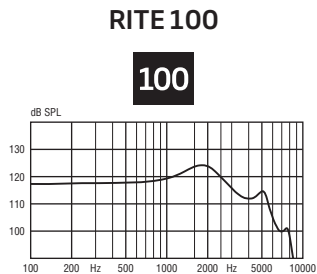

## Full-on Gain

Input: 50 dB SPL.  
Technical setting: A0

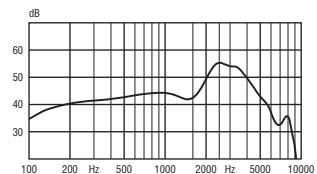
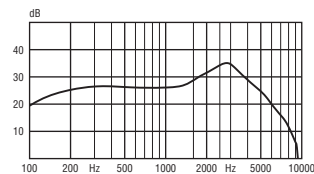

## Full-on Gain

Input: 50 dB SPL.  
Technical setting: A0

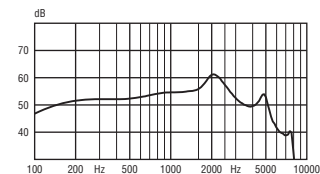
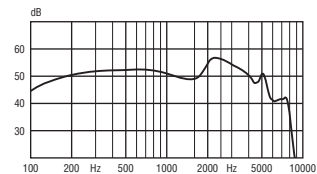



**TECHNICAL DATA**

**RITE**

Alta

**oticon**  
PEOPLE FIRST

Measurements according to American National Standard ANSI S 3.22 (2003) and S3.7 (1995).

Supply voltage:  
Battery Zinc Air 1.4 Volt

0 dB SPL ref. 20  $\mu$ Pa

**RITE 60**

**60**

|   |              |
|---|--------------|
| Peak OSPL90                             | 105 dB SPL   |
| HF Average OSPL90                       | 103 dB SPL   |
| Peak Full-on Gain                       | 35 dB        |
| HF Average Full-on Gain                 | 30 dB        |
| Reference Test Gain                     | 26 dB        |
| Frequency Range                         | 100-8300 Hz  |
| Total Harmonic Distortion 500 Hz        | <2%          |
| Total Harmonic Distortion 800 Hz        | <2%          |
| Total Harmonic Distortion 1600 Hz       | <2%          |
| Battery Consumption                     | 1.3 mA       |
| Equivalent Input Noise Level (omni/dir) | 16/24 dB SPL |
| HF Average SPLITS (left/right ear)      | 82/82 dB SPL |
| Attack Time                             | 1 ms         |
| Release Time                            | 120 ms       |

0 dB SPL ref. 20  $\mu$ Pa

**RITE 85**

**85**

|   |              |                |
|---|--------------|----------------|
| Peak OSPL90                             | 118 dB SPL   | 124 dB SPL     |
| HF Average OSPL90                       | 114 dB SPL   | 121 dB SPL     |
| Peak Full-on Gain                       | 55 dB        | 57 dB          |
| HF Average Full-on Gain                 | 47 dB        | 52 dB          |
| Reference Test Gain                     | 38 dB        | 44 dB          |
| Frequency Range                         | 100-8700 Hz  | 100-8100 Hz    |
| Total Harmonic Distortion 500 Hz        | <2%          | <2%            |
| Total Harmonic Distortion 800 Hz        | <2%          | <2%            |
| Total Harmonic Distortion 1600 Hz       | <2%          | <2%            |
| Battery Consumption                     | 1.2 mA       | 1.3 mA         |
| Equivalent Input Noise Level (omni/dir) | 18/25 dB SPL | 16/25 dB SPL   |
| HF Average SPLITS (left/right ear)      | 95/95 dB SPL | 101/101 dB SPL |
| Attack Time                             | 1 ms         | 1 ms           |
| Release Time                            | 60 ms        | 30 ms          |

**RITE 100**

**100**

### OSPL90 - Output Sound Pressure Level

Input: 90 dB SPL.  
Technical setting: A0

#### RITE 60

60

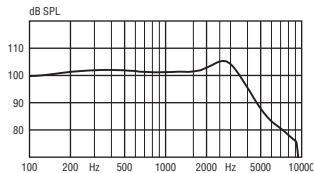

#### RITE 85

85

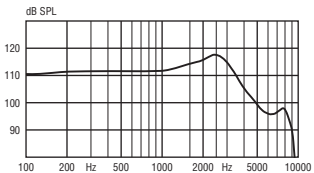

#### RITE 100

100

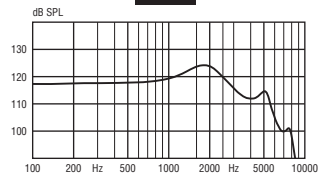

### OSPL90 - Output Sound Pressure Level

Input: 90 dB SPL.  
Technical setting: A0

### Full-on Gain

Input: 50 dB SPL.  
Technical setting: A0

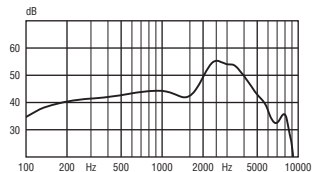
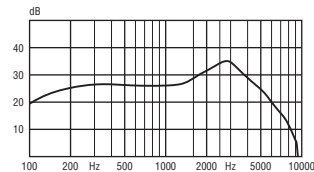

### Full-on Gain

Input: 50 dB SPL.  
Technical setting: A0

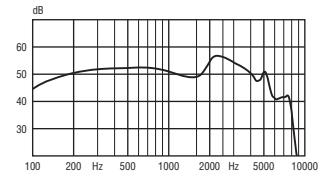

**TECHNICAL DATA**

**RITE**

Nera2, Ria2

**oticon**  
PEOPLE FIRST

Measurements according to American National Standard ANSI S 3.22 (2003) and S3.7 (1995).

Supply voltage:  
Battery Zinc Air 1.4 Volt

0 dB SPL ref. 20  $\mu$ Pa

**RITE 60**

**60**

|   |              |
|---|--------------|
| Peak OSPL90                             | 105 dB SPL   |
| HF Average OSPL90                       | 103 dB SPL   |
| Peak Full-on Gain                       | 35 dB        |
| HF Average Full-on Gain                 | 30 dB        |
| Reference Test Gain                     | 26 dB        |
| Frequency Range                         | 100-7000 Hz  |
| Total Harmonic Distortion 500 Hz        | <2%          |
| Total Harmonic Distortion 800 Hz        | <2%          |
| Total Harmonic Distortion 1600 Hz       | <2%          |
| Battery Consumption                     | 1.3 mA       |
| Equivalent Input Noise Level (omni/dir) | 16/24 dB SPL |
| HF Average SPLITS (left/right ear)      | 82/82 dB SPL |
| Attack Time                             | 1 ms         |
| Release Time                            | 120 ms       |

**RITE 85**

**85**

|              |                |                |
|--------------|----------------|----------------|
| 118 dB SPL   | 124 dB SPL     | 125 dB SPL     |
| 114 dB SPL   | 121 dB SPL     | 121 dB SPL     |
| 55 dB        | 57 dB          | 61 dB          |
| 47 dB        | 52 dB          | 56 dB          |
| 38 dB        | 44 dB          | 44 dB          |
| 100-7500 Hz  | 100-7200 Hz    | 100-6900 Hz    |
| <2%          | <2%            | <2%            |
| <2%          | <2%            | <2%            |
| <2%          | <2%            | <2%            |
| 1.2 mA       | 1.3 mA         | 1.3 mA         |
| 18/25 dB SPL | 16/25 dB SPL   | 16/28 dB SPL   |
| 95/95 dB SPL | 101/101 dB SPL | 109/109 dB SPL |
| 1 ms         | 1 ms           | 1 ms           |
| 60 ms        | 30 ms          | 123 ms         |

**RITE 100**

**100**

**RITE 105**

**105**

### OSPL90 - Output Sound Pressure Level

Input: 90 dB SPL.  
Technical setting: A0

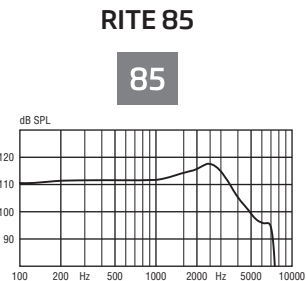
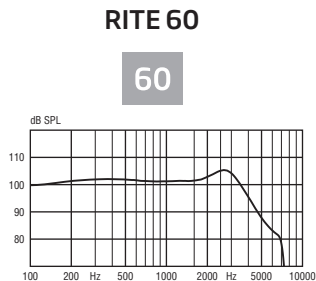

### OSPL90 - Output Sound Pressure Level

Input: 90 dB SPL.  
Technical setting: A0

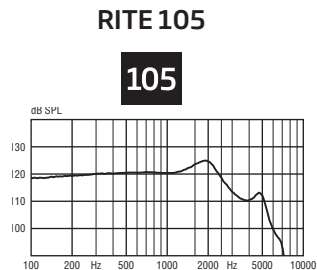
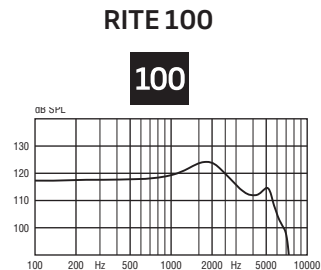

### Full-on Gain

Input: 50 dB SPL.  
Technical setting: A0

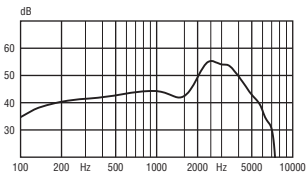
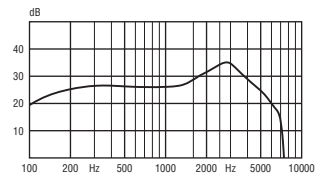

### Full-on Gain

Input: 50 dB SPL.  
Technical setting: A0

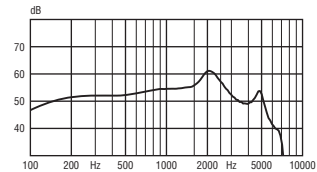
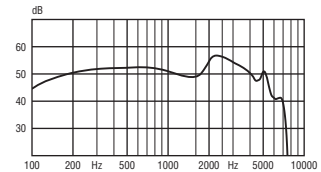

**TECHNICAL DATA**

**RITE**

Nera, Ria

**oticon**  
PEOPLE FIRST

Measurements according to American National Standard ANSI S 3.22 (2003) and S3.7 (1995).

Supply voltage:  
Battery Zinc Air 1.4 Volt

0 dB SPL ref. 20 µPa

### RITE 60

60

|   |              |
|---|--------------|
| Peak OSPL90                             | 105 dB SPL   |
| HF Average OSPL90                       | 103 dB SPL   |
| Peak Full-on Gain                       | 35 dB        |
| HF Average Full-on Gain                 | 30 dB        |
| Reference Test Gain                     | 26 dB        |
| Frequency Range                         | 100-7000 Hz  |
| Total Harmonic Distortion 500 Hz        | <2%          |
| Total Harmonic Distortion 800 Hz        | <2%          |
| Total Harmonic Distortion 1600 Hz       | <2%          |
| Battery Consumption                     | 1.3 mA       |
| Equivalent Input Noise Level (omni/dir) | 16/24 dB SPL |
| HF Average SPLITS (left/right ear)      | 82/82 dB SPL |
| Attack Time                             | 1 ms         |
| Release Time                            | 120 ms       |

0 dB SPL ref. 20 µPa

### RITE 85

85

|   |              |                |
|---|--------------|----------------|
| Peak OSPL90                             | 118 dB SPL   | 124 dB SPL     |
| HF Average OSPL90                       | 114 dB SPL   | 121 dB SPL     |
| Peak Full-on Gain                       | 55 dB        | 57 dB          |
| HF Average Full-on Gain                 | 47 dB        | 52 dB          |
| Reference Test Gain                     | 38 dB        | 44 dB          |
| Frequency Range                         | 100-7500 Hz  | 100-7200 Hz    |
| Total Harmonic Distortion 500 Hz        | <2%          | <2%            |
| Total Harmonic Distortion 800 Hz        | <2%          | <2%            |
| Total Harmonic Distortion 1600 Hz       | <2%          | <2%            |
| Battery Consumption                     | 1.2 mA       | 1.3 mA         |
| Equivalent Input Noise Level (omni/dir) | 18/25 dB SPL | 16/25 dB SPL   |
| HF Average SPLITS (left/right ear)      | 95/95 dB SPL | 101/101 dB SPL |
| Attack Time                             | 1 ms         | 1 ms           |
| Release Time                            | 60 ms        | 30 ms          |

### RITE 100

100



### OSPL90 - Output Sound Pressure Level

Input: 90 dB SPL.  
Technical setting: A0

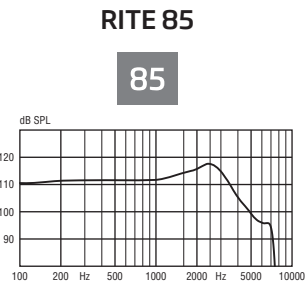
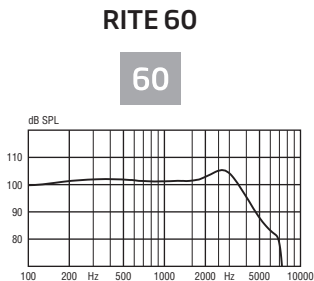

### OSPL90 - Output Sound Pressure Level

Input: 90 dB SPL.  
Technical setting: A0

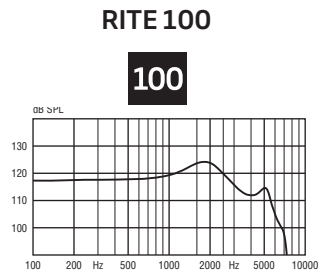

### Full-on Gain

Input: 50 dB SPL.  
Technical setting: A0

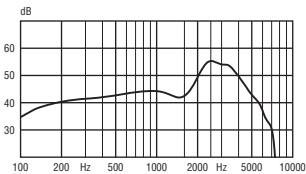
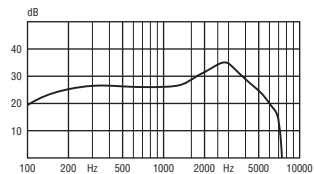

### Full-on Gain

Input: 50 dB SPL.  
Technical setting: A0

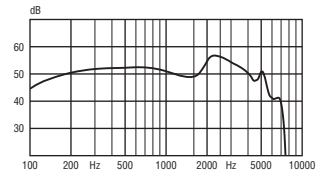

151824US/01.15

151824US/01.15

## People First

People First is our promise  
to empower people  
to communicate freely,  
interact naturally and  
participate actively



0000151824000001

**oticon**  
PEOPLE FIRST