

## INSTRUCTIONS FOR USE

BTE



Alta2 Pro Ti, Nera2 Pro Ti, Ria2 Pro Ti

## Introduction to this booklet

This booklet guides you in how to use and maintain your new hearing instrument. Please read the booklet carefully including the **Warning section**. This will help you to achieve the full benefit of your new hearing instrument.

Your Hearing Care Professional has adjusted the hearing instrument to meet your needs. If you have additional questions, please contact your Hearing Care Professional.

| **About** | [Start up](#) | [Handling](#) | [Options](#) | [Warnings](#) | [Tinnitus](#) | [Additional](#)s |

For your convenience this booklet contains a navigation bar to help you navigate easily through the different sections.

## Indication for use

The hearing instrument is intended to amplify and transmit sound to the ear and thereby compensate for mild to moderate-to-severe hearing impairment.

### IMPORTANT NOTICE

The hearing instrument amplification is uniquely adjusted and optimized to your personal hearing capabilities during the instrument fitting performed by your Hearing Care Professional.

## Table of content

<b>About</b>	Identify your hearing instrument style and ear piece	6
	BTE with sound hook and mold	8
	BTE with thin tube (Corda miniFit)	10
	Identify left and right instrument	12
<b>Start up</b>	Battery	13
	Turn the hearing instrument on and off	14
	When to replace a battery	15
<b>Handling</b>	Replace the battery	16
	Caring for your hearing instrument	18
	Sound hook with mold	20
	Put on the instrument with mold	21
	Clean the mold	22
	Wash the mold	23
	Thin tube (Corda miniFit)	24
	Put on the instrument with thin tube	25
	Clean the thin tube	26

	Thin tube with dome or GripTip	28
	Replace dome	29
	Thin tube with micro mold or LiteTip	30
	Maintain the micro mold or LiteTip	31
<b>Options</b>	Optional features and accessories	32
	Mute the hearing instrument (optional)	33
	Change programs (optional)	34
	Change volume (optional)	36
	Tamper-resistant battery drawer (optional)	38
	Wireless accessories (optional)	40
	Other options (optional)	42
<b>Warnings</b>	Warnings	44
<b>Tinnitus</b>	Tinnitus SoundSupport™ (optional)	54
<b>Additional</b>	Troubleshooting guide	66
	Water resistant	68
	Warranty certificate	70
	International warranty	71
	Mobile phone	72
	Technical information	74

## Identify your hearing instrument style and ear piece

There are two different attachments and several different ear pieces which classify your hearing instrument style. Please identify your attachment and ear piece. This will make it easier for you to navigate through this booklet.

### BTE with sound hook and mold

An instrument with a sound hook will have a mold as an ear piece.

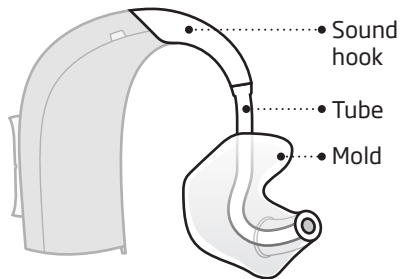

### BTE with thin tube (Corda miniFit)

An instrument with a

thin tube will have one of the following ear pieces - dome, GripTip, micro mold, or LiteTip.

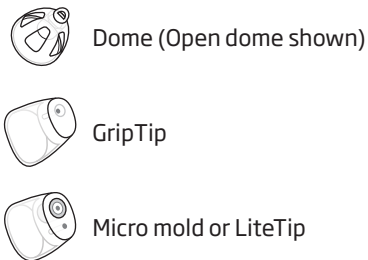
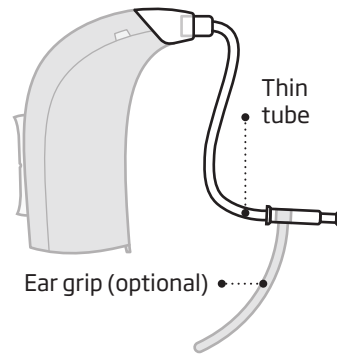

## BTE with sound hook and mold

### What it is

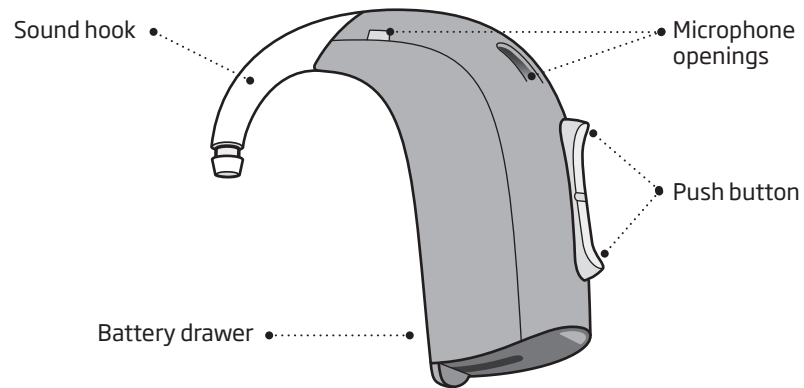

### What it does

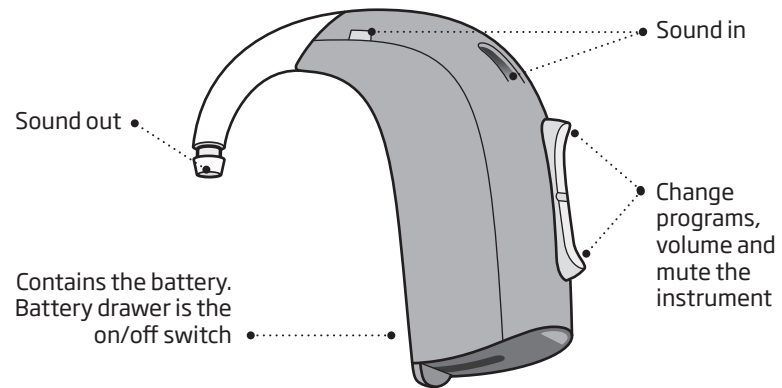

## BTE with thin tube (Corda miniFit)

### What it is

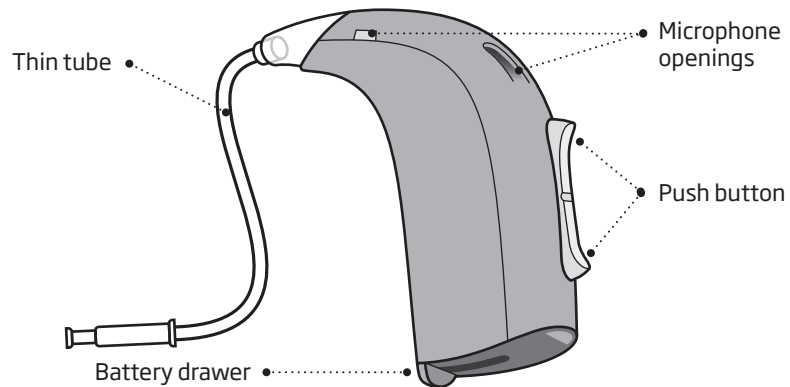

### What it does

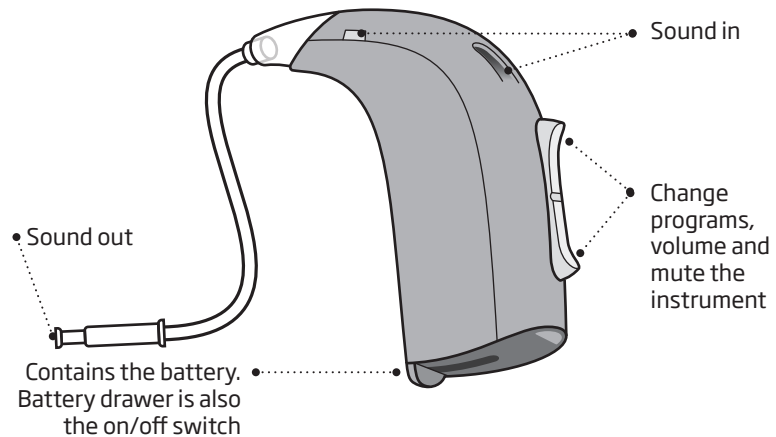

## Identify left and right instrument

It is important to distinguish between the left and the right instrument as they might be programmed differently.

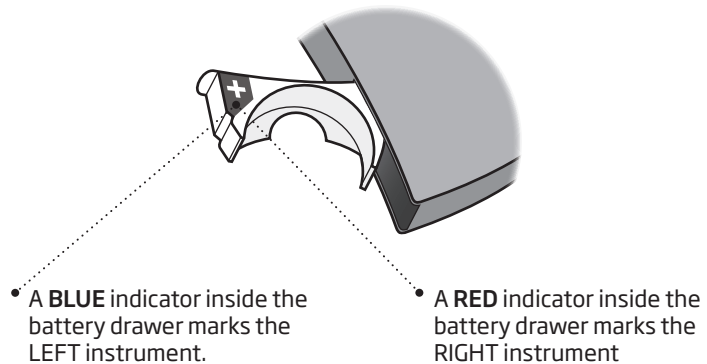

## Battery

Your hearing instrument is a miniature electronic device that runs on special batteries. To activate the hearing instrument, you must insert a new battery in the battery drawer. See how in the “Replace the battery” section.

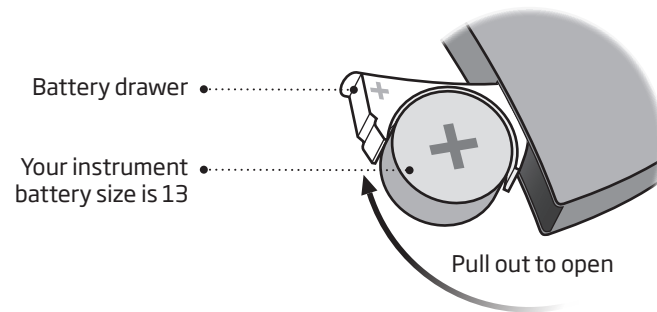

## Turn the hearing instrument on and off

The battery drawer is also used to switch the hearing instrument on and off. To preserve the battery, make sure your instrument is switched off when you are not wearing it.

**Turn ON**  
Close the battery drawer with the battery in place.

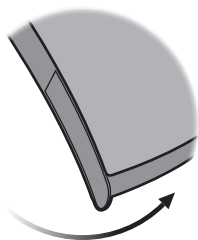

**Turn OFF**  
Open the battery drawer

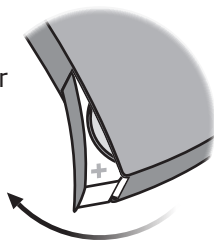

## When to replace a battery

When it is time to replace the battery you will hear two beeps repeated in moderate intervals until the battery runs out.



**Two beeps**  
= The battery is running low



**Four beeps**  
= The battery has run out

### Battery maintenance tip

To make sure the hearing instrument is always working bring spare batteries with you, or replace the battery before you leave home.



## Replace the battery

### 1. Remove

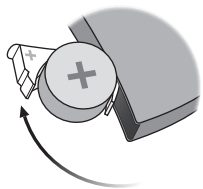

Fully open the battery drawer. Remove the battery.

### 2. Uncover



Remove the sticky label from the + side of the new battery.

### 3. Insert

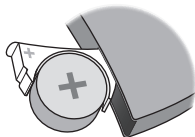

Insert the new battery into the battery drawer. Make sure the + side faces up.

### 4. Close

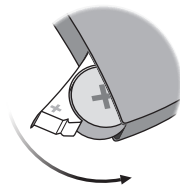

Close the battery drawer. The instrument will play a jingle through the ear piece. Hold the earpiece close to your ear to hear the jingle.

### Tip

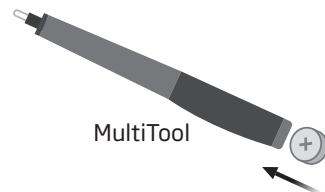

MultiTool

The MultiTool can be used for battery change. Use the magnetic end to remove and insert batteries.

The MultiTool is provided by your Hearing Care Professional.

## Caring for your hearing instrument

When handling your hearing instrument, hold it over a soft surface to avoid damage if you drop it.

### Clean the microphone openings

Carefully brush away debris from the openings. Gently brush the surface. Make sure the brush is not pressed in to the openings.

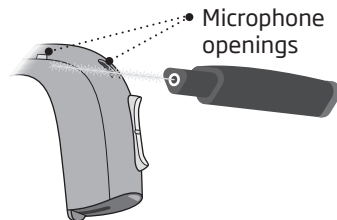

### IMPORTANT NOTICE

Use a soft, dry cloth to clean the hearing instrument. It must never be washed or immersed in water or other liquids

## The MultiTool

The MultiTool contains a brush and a wire loop for cleaning ear wax from the mould. The brush can be replaced and purchased from your Hearing Care Professional.

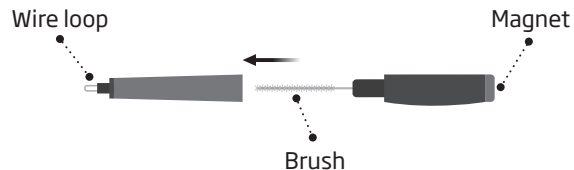

## Sound hook with mold

Read the following pages if you have a hearing instrument with a sound hook and a mold.

The mold is customized for you and fits your ear.



## Put on the instrument with mold

Step 1



Gently pull your ear outwards and press the mold in the direction of the ear canal, twisting slightly.

Step 2

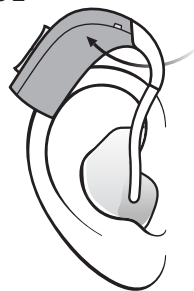

Place the hearing instrument behind your ear.

## Clean the mold

The mold should be cleaned regularly. Use a soft cloth to clean the surface of the mold. Use the MultiTool wire loop to clean the opening.

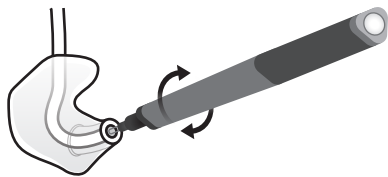

## Replace the tube

The tubing between the mold and the instrument should be replaced when it becomes yellow or stiff. Consult your Hearing Care Professional in relation to this.

## Wash the mold

### Step 1



Make sure you are able to identify which mold is for which instrument before disconnecting them from the instruments.

### Step 2



Disconnect the tube and mold from the hook. Hold the hook firmly, when pulling off the tube. Otherwise the instrument may be damaged.

### Step 3

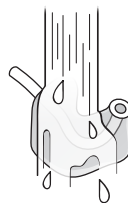

Wash the mold and tube using mild soap. Rinse and dry completely before reconnecting to the hearing instrument.

## Thin tube (Corda miniFit)

Read the following pages if your instrument has a thin tube (Corda miniFit) with either a dome, GripTip, micro mold or LiteTip ear piece.

Corda miniFit is a thin tube that brings the sound into your ear. The thin tube should always be used with an ear piece attached. Use only parts designed for your hearing instrument.

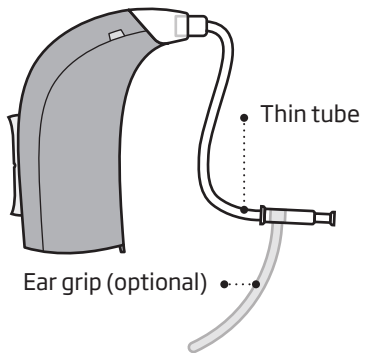

## Put on the instrument with thin tube

### Step 1



Place the hearing instrument behind your ear.

### Step 2

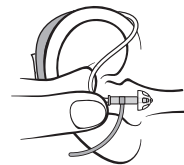

Hold the bend of the tube between your thumb and index finger. The ear piece should point towards the ear canal opening.

### Step 3

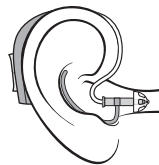

Gently push the ear piece into your ear canal until the thin tube sits close against the side of your head.

## Clean the thin tube

The thin tube should be cleaned to keep it clear from moisture and wax. If not cleaned it could become blocked with wax which means no sound will be able to come out.

**Step 1**

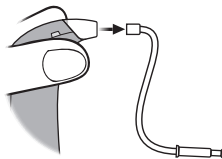

Pull the thin tube out of the hearing instrument

**Step 2**

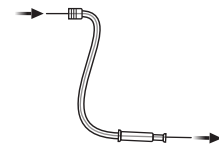

Push the cleaning tool all the way through the thin tube.

**Step 3**

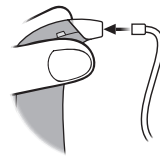

Reconnect the thin tube to the hearing instrument.

## Thin tube with dome or GripTip

There are 4 different types of domes, which are made of soft rubber material. If you have a dome check the type and size below. 

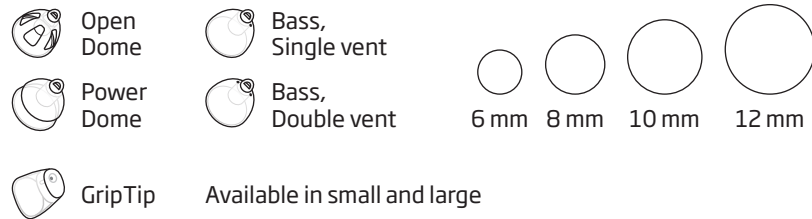

### IMPORTANT NOTICE

If the dome is not on the tube when removed from the ear, the dome might still be in the ear canal. Consult your Hearing Care Professional for further instructions.

## Replace dome

The dome should not be cleaned. When the dome is more or less filled with wax, replace it with a new one.

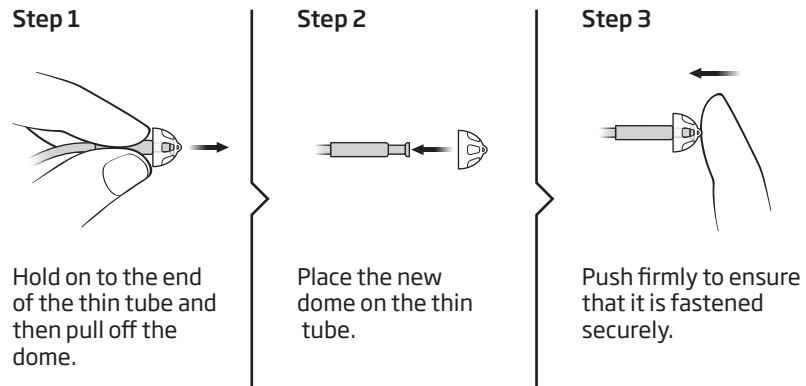

## Thin tube with micro mold or LiteTip

Read the following pages if you have a micro mold or LiteTip ear piece.  
The micro mold and LiteTip are customized for your ear shape.



• Micro mold



• LiteTip

## Maintain the micro mold or LiteTip

The ear piece should be cleaned regularly.

The wax filter in the ear piece should be replaced when clogged or when the hearing instrument does not sound normal.

Use the wax filter delivered by your Hearing Care Professional.

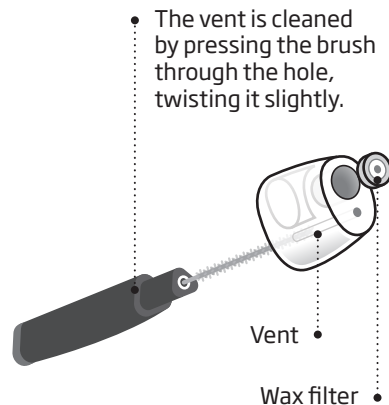



## Optional features and accessories

The features and accessories described on the following pages are optional. Please contact your Hearing Care Professional to find out how your hearing instrument is programmed.

If you experience difficult listening situations, a special program may be helpful. These are programmed by your Hearing Care Professional.

*Write down hearing situations where you may need help.*

---

---

---

### Mute the hearing instrument (optional)

Use the mute function if you need to silence the instrument while wearing it.

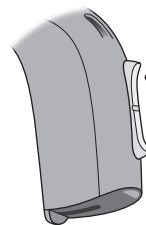

Apply a very long press to either end of the button to mute the instrument.  
To reactivate the instrument, push the button briefly.

#### **IMPORTANT NOTICE**

Do not use the mute function as an off switch, as the hearing instrument still draws current from the battery in this mode.

## **Change programs** (optional)



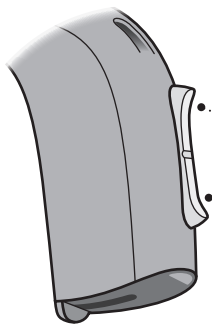

Your hearing instrument can have up to 4 different programs. These are programmed by your Hearing Care Professional.



Press up or down  
between programs

Note that you can change continuously between programs - both up and down in the program order. If for example you want to go from program 1 to 4, you can press the down button once instead of pressing the up button 3 times.

## To be filled out by the Hearing Care Professional

Program	Sound you will hear when activated	When to use
1	 "1 beep"	
2	 "2 beeps"	
3	 "3 beeps"	
4	 "4 beeps"	

Program change:

LEFT

RIGHT

Short press

Long press

## **Change volume** (optional)

The push button allows you to adjust the volume.  
You will hear a click when you turn up or down the volume.

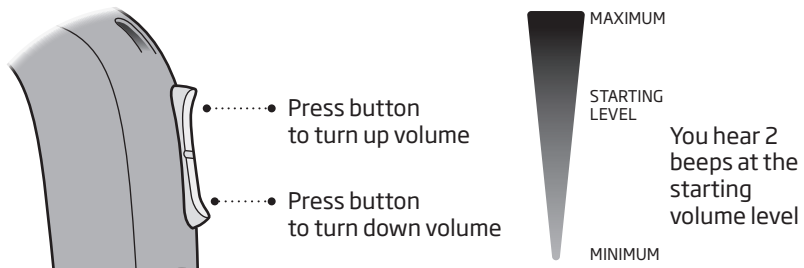

**To be filled out by the Hearing Care Professional**

Volume change	<input type="checkbox"/> LEFT	<input type="checkbox"/> RIGHT	<input type="checkbox"/> Short press
---------------	-------------------------------	--------------------------------	--------------------------------------

## **Quick reset**

If you wish to return to the standard settings of the instrument programmed by your Hearing Care Professional, simply open and then close the battery drawer.

**Open**

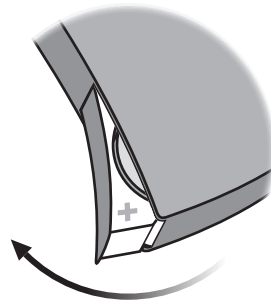

**Close**

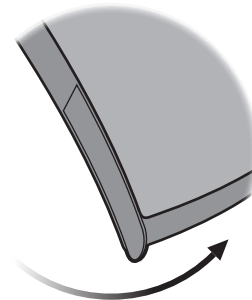

## □ **Tamper-resistant battery drawer** (optional)

To keep the battery out of reach of infants, small children and people with learning difficulties, a tamper-resistant battery drawer should be used. Use a small screwdriver to lock and unlock the drawer.

### **IMPORTANT NOTICE**

Avoid excessive force to open the battery drawer when in the locked position. Do not force the battery drawer beyond its fully opened position. Make sure to insert the battery correctly.

Please contact your Hearing Care Professional if you suspect the tamper-resistant effectiveness and locking ability is damaged.

### **Unlock the battery drawer**

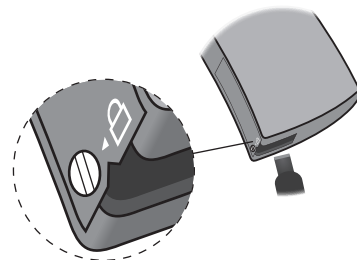

Use the screwdriver to turn the screw to unlock position (vertical). Insert the screwdriver into the slit in the bottom of the hearing instrument and push the door open.

### **Lock the battery drawer**

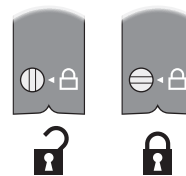

Make sure the drawer is completely closed. Turn the screw to the locked position (horizontal).

## **Wireless accessories** (optional)

As an enhancement to your wireless hearing instrument a broad range of wireless accessories are available.

### **ConnectLine**

ConnectLine is a family of products that allows you to receive audio signals from TVs, phones, music players, PCs or an external microphone wirelessly through your hearing instrument.

### **Remote Control**

The Remote Control offers an opportunity to change program or adjust the volume in your hearing instrument.

### **FM**

Your hearing instrument supports the option of attaching an FM system. The FM system allows you to receive speech or audio signals directly to your hearing instrument from a dedicated transmitter.

For detailed information on wireless accessories contact your Hearing Care Professional or visit **[www.oticonusa.com](http://www.oticonusa.com)**.

## □ **Other options** (optional)



### **Telecoil**

Telecoil helps you hear better when using a telephone with a built in loop or when you are in buildings with teleloop systems such as theaters, churches or lecture rooms. This symbol or a similar sign is shown wherever a teleloop has been installed.



### **Autophone**

is a program that will automatically be activated when you place a special magnet on your telephone next to the sound outlet.

### **Direct Audio Input (DAI)**

allows your hearing instrument to receive signals directly from external sources such as TV, radio, music players, etc. The DAI adaptor is mounted to your instrument and via a cable connected to an external sound source.

For detailed information on these options contact your Hearing Care Professional or visit [www.oticonusa.com](http://www.oticonusa.com)

#### **IMPORTANT NOTICE**

When the DAI is connected to an audio source plugged into a wall outlet, the audio source must comply with IEC-60065, IEC-60601 or equivalent safety standards.

## Warnings

You should familiarize yourself fully with the following general warnings before using your hearing instrument for personal safety and to secure correct use.

Consult your Hearing Care Professional if you experience unexpected operations or events with your hearing instrument.

### Usage of hearing instruments

- Hearing instruments should be used only as directed and adjusted by your Hearing Care Professional. Misuse can result in sudden and permanent hearing loss.

- Never allow others to wear your hearing instrument as incorrect usage could cause permanent damage to their hearing.

### Choking hazards & risk of swallowing batteries

- Hearing instruments, their parts, and batteries should be kept out of reach of children and anyone who might swallow these items, or otherwise cause injury to themselves.

- Batteries have occasionally been mistaken for pills. Therefore check your medicine carefully before swallowing any pills.
- Most hearing instruments can be supplied with a tamper-resistant battery drawer upon request. This is strongly recommended for infants, small children, and people with learning difficulties.
- Children below 36 months must always use a tamper-resistant battery drawer. This option is available in BTE, miniBTE, RITE and miniRITE instruments.

*If a battery or hearing instrument is swallowed, see a doctor immediately and contact the National Poison Center 1-800-222-1222 or National Battery Ingestion Hotline at 202-625-3333.*

### Battery use

- Always use batteries recommended by your Hearing Care Professional. Batteries of low quality may leak and cause bodily harm.
- Never attempt to recharge your batteries and never dispose of batteries by burning them. There is a risk that the batteries will explode.

## Warnings

### Dysfunction

- Be aware of the possibility that your hearing instrument may stop working without notice. Keep this in mind when you depend on warning sounds (e.g., when you are in traffic). The hearing instruments may stop functioning, for instance if the batteries have expired or if the tubing is blocked by moisture or ear wax.

### Active implants

- Caution must be taken with active implants. In general, follow the guidelines recommended by manufacturers of implantable defibrillators and pacemakers regarding use with mobile phones.
- If you wear an active implant, then keep the hearing instrument more than 15 cm away from the implant and Autophone magnet or MultiTool (has a built in magnet) more than 30 cm away from the implant. E.g., do not carry them in a breast pocket.

- If you have an active brain implant, please contact the manufacturer of your implantable device for information about the risk of disturbance.

### Explosives

- The power source in your hearing instrument has insufficient energy to cause fire in normal usage conditions. The hearing instrument has not been tested for compliance with international standards concerning explosive environments. It is recommended not to use your hearing instrument in areas where there is a danger of explosions.

### X-ray, CT, MR, PET scanning and electrotherapy

- Remove your hearing instrument for example during X-ray, CT / MR / PET scanning electrotherapy or surgery as your hearing instrument may be damaged when exposed to strong fields.



## Warnings

### Avoiding heat and chemicals

- Your hearing instrument must never be exposed to extreme heat e.g., left inside a parked car in the sun.
- Your hearing instrument must not be dried in microwave ovens or other ovens.
- The chemicals in cosmetics, hairspray, perfume, after shave lotion, suntan lotion and insect repellent can damage your hearing instrument. Always remove your hearing instrument before applying such products and allow time to dry before putting it on.

### Possible side effects

- Hearing instruments, molds or domes may cause an accelerated accumulation of ear wax.
- The otherwise non-allergenic materials used in hearing instruments may in rare cases cause a skin irritation or any other unusual condition.

*Please seek consultation with a physician if these conditions occur.*

### Interference

- Your hearing instrument has been thoroughly tested for interference, according to the most stringent international standards. However, interference with your hearing instrument and other devices may occur, (e.g., some mobile telephones, citizens band systems, and shop alarm systems). If this occurs increase the distance between the hearing instrument and the device.

## Warnings

### **Warning to hearing instrument dispensers**

A hearing instrument dispenser should advise a prospective hearing instrument user to consult immediately with a licensed physician (preferably an ear specialist) before dispensing a hearing instrument if the hearing instrument dispenser determines through inquiry, actual observation, or review of any other available information concerning the prospective user, that the prospective user has any of the following conditions:

- (i) Visible congenital or traumatic deformity of the ear.
- (ii) History of active drainage from the ear within the previous 90 days.

- (iii) History of sudden or rapidly progressive hearing loss within the previous 90 days.
- (iv) Acute or chronic dizziness.
- (v) Unilateral hearing loss of sudden or recent onset within the previous 90 days.
- (vi) Audiometric air-bone gap equal to or greater than 15 decibels at 500 Hertz (Hz), 1,000 Hz, and 2,000 Hz.
- (vii) Visible evidence of significant cerumen accumulation or a foreign body in the ear canal.
- (viii) Pain or discomfort in the ear.

Special care should be exercised in selecting and fitting a hearing instrument whose maximum sound pressure capability exceeds 132 dB SPL as there may be risk of impairing the remaining hearing of the hearing instrument user.

### **Important notice for prospective hearing instrument users**

- Good health practice requires that a person with a hearing loss have a medical evaluation by a licensed physician (preferably a physician who specializes in diseases of the ear) before purchasing a hearing instrument. Licensed physicians who specialize in diseases of the ear are often referred to as

Otolaryngologists, Otologists or Otorhinolaryngologists. The purpose of medical evaluation is to ensure that all medically treatable conditions that may affect hearing are identified and treated before the hearing instrument is purchased. Following the medical evaluation, the physician will give you a written statement that states that your hearing loss has been medically evaluated and that you may be considered a candidate for a hearing instrument. The physician will refer you to an audiologist or a hearing instrument dispenser, as appropriate, for a hearing instrument evaluation.

## Warnings

- The audiologist or hearing instrument dispenser will conduct a hearing instrument evaluation to assess your ability to hear with and without a hearing instrument. The hearing instrument evaluation will enable the audiologist or dispenser to select and fit a hearing instrument to your individual needs. If you have reservations about your ability to adapt to amplification, you should inquire about the availability of a trial, rental or purchase-option program. Many hearing instrument dispensers now offer programs that permit you to wear a hearing instrument for a period of time for a nominal fee, after which you may decide if you want to purchase

the hearing instrument. Federal law limits the sale of hearing instruments to those individuals who have obtained a medical evaluation from a licensed physician.

- Federal law permits a fully informed adult to sign a waiver statement declining the medical evaluation for religious or personal beliefs that preclude consultation with a physician. The exercise of such a waiver is not in your best health interest and its use is strongly discouraged. A hearing instrument will not restore normal hearing and will not prevent or improve a hearing impairment resulting from organic conditions. A hearing instrument is

only part of hearing rehabilitation and may need to be supplemented by auditory training and lip reading.

### **Children with hearing loss**

In addition to seeing a physician for medical evaluation, a child with a hearing loss should be directed to an audiologist for evaluation and rehabilitation, since hearing loss may cause problems in language development and educational and social growth of a child. An audiologist is qualified by training and experience to assist in the evaluation and rehabilitation of a child with a hearing loss. If the user is an infant, small child, or person of mental incapacity, it is recommended that the hearing instrument be modified with a tamper-resistant battery compartment.

## **Tinnitus SoundSupport™ (optional)**

### **Intended use of Tinnitus SoundSupport**

Tinnitus SoundSupport is a tool intended to generate sounds to provide temporary relief to patients suffering from tinnitus as part of a tinnitus management program.

The target population is the adult population (>18yrs).

Tinnitus SoundSupport is targeted for licensed Hearing Care Professionals (audiologists, hearing aid specialists, or otolaryngologists) who are familiar with the evaluation and treatment of tinnitus and hearing losses. The fitting of Tinnitus SoundSupport must be done by a Hearing Care Professional participating in a tinnitus management program.

## **Guidelines for tinnitus sound generator users**

These instructions contain information about Tinnitus SoundSupport, which may have been enabled in your hearing instruments by your Hearing Care Professional.

Tinnitus SoundSupport is an electronic tinnitus management device intended to generate noise of sufficient intensity and bandwidth to help manage ringing in the ears or internal head noises.

Your Hearing Care Professional will also be able to offer the appropriate follow-up care. It is important to follow the advice and directions regarding such care.

## **Prescription use only**

### **CAUTION:**

Good health practice requires that a person reporting tinnitus have a medical evaluation by a licensed ear physician before using a sound generator. The purpose of such an evaluation is to ensure that any medically treatable condition that may cause tinnitus is identified and treated prior to using a sound generator.

Federal law restricts this device to sale by or on the order of a doctor, audiologist or other hearing care practitioner licensed to dispense hearing instruments in your state-in accordance with all applicable rules and regulations.

Federal law permits a fully informed adult to sign a waiver statement declining the medical evaluation for religious or personal beliefs that preclude consultation with a physician - in accordance with all applicable state rules and regulations.

## **Sound options and volume adjustment**

Tinnitus SoundSupport is programmed by your Hearing Care Professional to match your hearing loss and preferences for tinnitus relief. It offers a number of different sound options. Together with your Hearing Care Professional, you select the sound(s) preferred by you.

### **Tinnitus SoundSupport programs**

Together with your Hearing Care Professional you decide in which programs you may want to have Tinnitus SoundSupport activated. The sound generator can be activated in up to four different programs.

An overview of the Tinnitus SoundSupport programs and the volume control configuration is available at the end of this manual.

## **Volume adjustments with Tinnitus SoundSupport**

When you select a hearing instrument program where Tinnitus SoundSupport is activated, the push button on your hearing instrument works as a volume control only for the sound produced by Tinnitus SoundSupport.

Your Hearing Care Professional will set the volume control for the sound generator in one of two ways: 1) Changing volume in each ear separately or 2) Changing volume in both ears simultaneously.

### **1) How to change Tinnitus SoundSupport volume in each ear separately**

To **increase** volume, use a short press on the upper part of the push-button.  
To **decrease** volume, use a short press on the lower part of the push-button.

You hear a click when you increase or decrease the volume.

### **2) How to change Tinnitus SoundSupport volume in both ears simultaneously**

You can use one instrument to increase/decrease the sound in both instruments. When changing the volume in one instrument, the volume on the other instrument will follow.

To **increase** volume, use a short press on the upper part of the push-button.  
To **decrease** volume, use a short press on the lower part of the push-button.

You hear a click when you increase or decrease the volume.

### **Mute**

If you are in a program where Tinnitus SoundSupport is activated, the Mute functionality will mute both the environmental sounds and the sound from Tinnitus SoundSupport.  
See “Mute the hearing instrument” under section “Options” for how to mute the instrument.

### **CAUTION - daily use**

The volume levels of Tinnitus SoundSupport can be set to a level which could lead to permanent hearing damage when used for a prolonged period of time.

Your Hearing Care Professional will advise you of the maximum amount of time per day you should use Tinnitus SoundSupport. It should never be used at uncomfortable levels.

### **Tinnitus SoundSupport: Limitation on use**

<input type="checkbox"/>	No limitation on use
<input type="checkbox"/>	Limited use, maximum _____ hours per day

*To be filled out by your Hearing Care Professional.*

## **Important information for Hearing Care Professionals about Tinnitus SoundSupport**

### **Device description**

Tinnitus SoundSupport is a module function that can be enabled in the hearing instruments by the Hearing Care Professional.

### **Maximum wearing time**

The wearing time of Tinnitus SoundSupport will decrease as you increase the level above 80 dB(A) SPL. The fitting software will automatically display a warning when the instrument exceeds 80 dB(A) SPL. See Wearing Time Indicator next to the tinnitus fitting graph in the fitting software.

## Important information for Hearing Care Professionals about Tinnitus SoundSupport

### If the volume control is enabled

By default the volume control for the sound generator is deactivated in the instrument. Risk of noise exposure increases when the volume control is enabled.

In the Tinnitus volume control tab on the “Buttons & Indicators” screen a warning will be displayed when the highest volume control setting in the instrument exceed 80 dB(A) SPL.

Using the table provided, calculate the maximum wearing time for your patient based on:

1. The output of the program with the highest dB(A)SPL level.\*  
**plus**
2. the decibel range of the volume control.

*\* Can be found by hovering over signal level control.*

Instruct your patient accordingly and record your patient’s wearing time in the table “Tinnitus SoundSupport: Limitation on use”, page 60 in this booklet.

### Maximum wearing time of Tinnitus SoundSupport

total dB(A) SPL	Wearing time/hours per day
< 81	Full day
82	16
85	8
88	4
90	3

Ref. OSHA (Occupational Safety & Health Administration, U.S. department of Labour) / DIRECTIVE 2003/10/EC on the minimum health and safety requirements regarding the exposure of workers to the risks arising from physical agents (noise) / Occupational exposure to noise: evaluation, prevention and control - Special Report S 64, WHO.



## Warnings related to Tinnitus

If your Hearing Care Professional has activated the sound generator Tinnitus SoundSupport, please pay attention to the below warnings.

- There are some potential concerns associated with the use of any sound generated by a tinnitus management device. Among them are the potential for worsening of tinnitus and or a possible change in hearing thresholds.
- Should you experience or notice a change in hearing or tinnitus, or any dizziness, nausea, headaches, heart palpitations or possible skin irritation at the point of contact with the device, you should immediately discontinue use of the device and seek a consultation with a medical, audiology, or other Hearing Care Professional.
- As with any device, misuse of the sound generator feature could present some potentially harmful effects. Care should be taken to prevent the unauthorized use and to keep the device out of the reach of children and pets.
- A Hearing Care Professional should advise a prospective sound generator user to consult promptly with a licensed physician (preferably an ear specialist) before using a sound generator if the Hearing Care Professional determines through inquiry, actual observation, or review or any other available information concerning the prospective user that the prospective user has any of the following conditions:
  - i. Visible congenital or traumatic deformity of the ear.
  - ii. History of active drainage from the ear within the previous 90 days.
  - iii. History of sudden or rapidly progressive hearing loss within the previous 90 days.
  - iv. Acute or chronic dizziness.
  - v. Unilateral hearing loss of sudden or recent onset within the previous 90 days.
  - vi. Audiometric air-bone gap equal to or greater than 15dB at 500 Hz, 1000 Hz, and 2000 Hz.
  - vii. Visible evidence of significant cerumen accumulation or a foreign body in the ear canal.
  - viii. Pain or discomfort in the ear.

## Troubleshooting guide

### for your hearing instrument

Symptom	Possible causes	Solutions
No sound	Worn-out battery	Replace the battery
	Clogged tube or earpieces (mould, dome, GripTip, micro mould or LiteTip)	Clean mould Clean Corda miniFit (thin tube), replace dome or GripTip or replace wax filter
Intermittent or reduced sound	Clogged sound outlet	Clean mold Clean Corda miniFit (thin tube), replace dome or GripTip or replace wax filter
	Moisture	Wipe battery with a dry cloth and/or dry tube
	Worn-out battery	Replace the battery
	Clogged damping filter in sound hook	Contact your Hearing Care Professional for assistance
Squealing noise	Hearing instrument earpiece inserted incorrectly	Re-insert earpiece (mold, dome, GripTip, micro mold or LiteTip)
	Ear wax accumulated in ear canal	Have ear canal examined by your doctor

If none of the above solutions work, consult your Hearing Care Professional for assistance.

## Water resistant

Your hearing instrument is water resistant which means it is designed to be worn in all daily life situations. Therefore you do not have to worry about sweat or getting wet in the rain. Should your hearing instrument come in contact with water and stop working, please follow these guidelines:

1. Gently wipe off any water
2. Open the battery drawer and remove the battery and gently wipe off any water in the battery drawer
3. Let the hearing instrument dry with the battery drawer left open for approximately 30 minutes
4. Insert a new battery

### IMPORTANT NOTICE

Do not wear your hearing instrument while showering or participating in water activities. Do not immerse your hearing instrument in water or other liquids.

## Warranty certificate

Name of owner: \_\_\_\_\_

Dispenser: \_\_\_\_\_

Dispenser address: \_\_\_\_\_

Dispenser phone: \_\_\_\_\_

Purchase date: \_\_\_\_\_

Warranty period: \_\_\_\_\_ Month: \_\_\_\_\_

Model left: \_\_\_\_\_ Serial no.: \_\_\_\_\_

Model right: \_\_\_\_\_ Serial no.: \_\_\_\_\_

Battery size: \_\_\_\_\_

## International warranty

Your hearing instrument is covered by an international limited warranty issued by the manufacturer for a period of 12 months from the date of delivery. This limited warranty covers manufacturing and material defects in the hearing instrument itself, but not accessories such as batteries, tubing, ear wax filters etc. Problems arising from improper handling or care, excessive use, accidents, repairs made by an unauthorised party, exposure to corrosive conditions, physical changes in your ear, damage due to foreign objects entering the device, or incorrect adjustments are NOT covered by the limited warranty and may void it. The above warranty does not affect any legal rights that you

might have under applicable national legislation governing sale of consumer goods. Your Hearing Care Professional may have issued a warranty that goes beyond the clauses of this limited warranty. Please consult him/her for further information.

### **If you need service**

Take your hearing instrument to your Hearing Care Professional, who may be able to sort out minor problems and adjustments immediately.

## Mobile phone

Some hearing instrument users have reported a buzzing sound in their hearing instrument when they are using mobile phones, indicating that the mobile phone and hearing instrument may not be compatible. According to the ANSI C63.19 standard (ANSI C63.19–2007 American National Standard Methods of Measurement of Compatibility Between Wireless Communications Devices and Hearing Aids), the compatibility of a particular hearing instrument and mobile phone can be predicted by adding the rating for the hearing instrument immunity to the rating for the mobile phone emissions. For example, the sum of a

hearing instrument rating of 2 (M2/T2) and a telephone rating of 3 (M3/T3) would result in a combined rating of 5. Any combined rating that equals at least 5 would provide “normal use”; a combined rating of 6 or greater would indicate “excellent performance”.

The immunity of this hearing instrument is M3/T3. The equipment performance measurements, categories, and system classifications are based upon the best information available but cannot guarantee that all users will be satisfied.

### IMPORTANT NOTICE

The performance of individual hearing instruments may vary with individual mobile phones. Therefore, please try this hearing instrument with your mobile phone or, if you are purchasing a new phone, be sure to try it with your hearing instrument prior to purchase.

For additional guidance, please ask your mobile phone provider for the booklet entitled “Hearing Aid Compatibility with Digital Wireless Mobile Phones.”

## Technical information

The hearing instrument contains a radio transmitter using short range magnetic induction technology working at 3.84 MHz. The magnetic field strength of the transmitter is < -42 dB $\mu$ A/m @ 10m.

The emission power from the radio system is well below international emission limits for human exposure. For comparison, the radiation of the hearing instrument is lower than unintended electromagnetic radiation from for example halogen lamps, computer monitors, dishwashers, etc. The hearing instrument complies with international standards concerning Electromagnetic Compatibility.

Due to the limited space available on the instruments all relevant approval markings are found in this document.

The hearing instrument contains a module with:

FCC ID: U28FU2BTERIT  
IC: 1350B-FU2BTERIT

The device complies with Part 15 of the FCC rules and RSS-210 of Industry Canada.

Operation is subject to the following two conditions:

1. This device may not cause harmful interference.
2. This device must accept any interference received, including interference that may cause undesired operation.

Changes or modifications not expressly approved by the party responsible for compliance could void the user's authority to operate the equipment.

More information: [www.oticon.com](http://www.oticon.com)

Oticon declares that this hearing instrument is in compliance with the essential requirements and other relevant provisions of Directive 1999/5/EC.

Declaration of conformity is available at:

Oticon A/S  
Kongebakken 9  
DK-2765 Smørum  
Denmark  
www.oticon.com

CE 0543 0682



Waste from electronic equipment must be handled according to local regulations.



N1175

IP58

### Settings overview for your hearing instrument

Left			Right	
<input type="checkbox"/> Yes	<input type="checkbox"/> No	Volume control	<input type="checkbox"/> Yes	<input type="checkbox"/> No
<input type="checkbox"/> Yes	<input type="checkbox"/> No	Program shift	<input type="checkbox"/> Yes	<input type="checkbox"/> No
<input type="checkbox"/> Yes	<input type="checkbox"/> No	Mute	<input type="checkbox"/> Yes	<input type="checkbox"/> No
<input type="checkbox"/> Yes	<input type="checkbox"/> No	Tinnitus SoundSupport	<input type="checkbox"/> Yes	<input type="checkbox"/> No
Volume control indicators				
<input type="checkbox"/> On	<input type="checkbox"/> Off	Beeps at min /max volume	<input type="checkbox"/> On	<input type="checkbox"/> Off
<input type="checkbox"/> On	<input type="checkbox"/> Off	Clicks when changing volume	<input type="checkbox"/> On	<input type="checkbox"/> Off
<input type="checkbox"/> On	<input type="checkbox"/> Off	Beeps at preferred volume	<input type="checkbox"/> On	<input type="checkbox"/> Off
Battery indicators				
<input type="checkbox"/> On	<input type="checkbox"/> Off	Low battery warning	<input type="checkbox"/> On	<input type="checkbox"/> Off

Hearing program description		
Program No.	Option	The volume control adjusts: (select one)
1		<input type="checkbox"/> Environmental sounds <input type="checkbox"/> Tinnitus SoundSupport
2		<input type="checkbox"/> Environmental sounds <input type="checkbox"/> Tinnitus SoundSupport
3		<input type="checkbox"/> Environmental sounds <input type="checkbox"/> Tinnitus SoundSupport
4		<input type="checkbox"/> Environmental sounds <input type="checkbox"/> Tinnitus SoundSupport
<b>The volume control in Tinnitus SoundSupport is enabled:</b>		
<input type="checkbox"/> Changing volume in each ear separately <input type="checkbox"/> Changing volume in both ears simultaneously		



**TECHNICAL DATA**

**BTE**

Alta2 Pro Ti

**oticon**  
PEOPLE FIRST

Measurements according to American National Standard ANSI S 3.22 (2003) and S3.7 (1995).

Supply voltage:  
Battery Zinc Air 1.4 Volt

**BTE13 85**

0 dB SPL ref. 20 mPa

**85**

Peak OSPL90	117 (123*) dB SPL
HF Average OSPL90	113 (106*) dB SPL
Peak Full-on Gain	51 (59*) dB
HF Average Full-on Gain	44 (41*) dB
Reference Test Gain	36 dB
Frequency Range	100-7700 Hz
Total Harmonic Distortion 500 Hz	< 2%
Total Harmonic Distortion 800 Hz	< 2%
Total Harmonic Distortion 1600 Hz	< 2%
Battery Consumption	1.1 mA
Equivalent Input Noise Level (omni/dir)	18/27 dB SPL
HF Average SPLITS (left/right ear)	94/94 dB SPL
Attack Time	1 ms
Release Time	55 ms

\* For instruments fitted with thin tube

**BTE13 85**

**85**

### OSPL90 - Output Sound Pressure Level

Input: 90 dB SPL.

Technical setting: A0

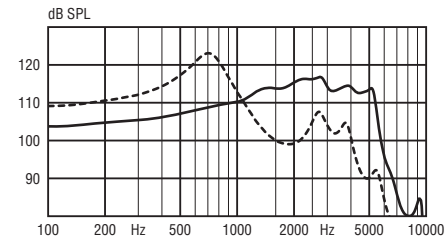

### Full-on Gain

Input: 50 dB SPL.

Technical setting: A0

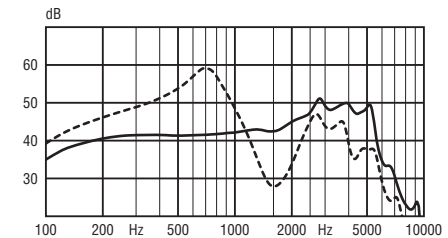

- Sound Hook w/Damper
- - - Thin tube (size 1/0.9)

**TECHNICAL DATA**

**BTE**

Nera2 Pro Ti, Ria2 Pro Ti

**oticon**  
PEOPLE FIRST

Measurements according to American National Standard ANSI S 3.22 (2003) and S3.7 (1995).

Supply voltage:  
Battery Zinc Air 1.4 Volt

**BTE13 85**

0 dB SPL ref. 20 mPa

**85**

Peak OSPL90	117 (123*) dB SPL
HF Average OSPL90	113 (106*) dB SPL
Peak Full-on Gain	51 (59*) dB
HF Average Full-on Gain	44 (41*) dB
Reference Test Gain	36 dB
Frequency Range	100-7000 Hz
Total Harmonic Distortion 500 Hz	< 2%
Total Harmonic Distortion 800 Hz	< 2%
Total Harmonic Distortion 1600 Hz	< 2%
Battery Consumption	1.1 mA
Equivalent Input Noise Level (omni/dir)	18/27 dB SPL
HF Average SPLITS (left/right ear)	94/94 dB SPL
Attack Time	1 ms
Release Time	55 ms

\* For instruments fitted with thin tube

**BTE13 85****85****OSPL90 - Output Sound Pressure Level**

Input: 90 dB SPL.

Technical setting: A0

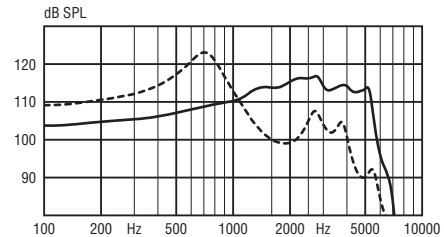
**Full-on Gain**

Input: 50 dB SPL.

Technical setting: A0

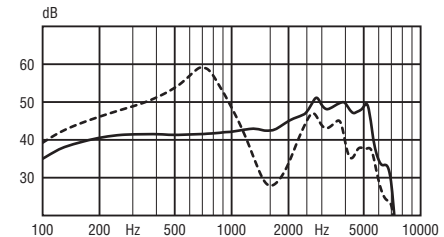

- Sound Hook  
w/Damper
- - - Thin tube  
(size 1/0.9)

## People First

People First is our promise  
to empower people  
to communicate freely,  
interact naturally and  
participate actively



0000151858000001

**oticon**  
PEOPLE FIRST