

# Instructions for use

BTE13 SP

Dynamo



## Introduction to this booklet

This booklet guides you in how to use and maintain your new hearing instrument. Please read the booklet carefully including the **Warning section**. This will help you to achieve the full benefit of your new hearing instrument.

Your Hearing Care Professional has adjusted the hearing instrument to meet your needs. If you have additional questions, please contact your Hearing Care Professional.

For your convenience, this booklet contains a navigation bar to help you navigate easily through the different sections.

| **About** | Start up | Handling | Options | Warnings | More info |

## **Intended use**

The hearing instrument is intended to amplify and transmit sound to the ear and thereby compensate for severe to profound hearing impairment.

### **IMPORTANT NOTICE**

The hearing instrument amplification is uniquely adjusted and optimised to your personal hearing capabilities during the instrument fitting performed by your Hearing Care Professional.

# Table of content

<b>About</b>	Instrument view	6
	Identify left and right hearing instrument	8
	Battery (size 13)	9
<b>Start up</b>	Turn the hearing instrument on and off	10
	When to replace a battery	11
	How to replace the battery	12
<b>Handling</b>	Caring for your hearing instrument	14
	Sound hook with mould	16
	Put on the hearing instrument with mould	17
	Clean the mould	18
	Wash the mould	19
<b>Options</b>	Optional features and accessories	20
	Mute the hearing instrument (optional)	21
	Change volume	22
	Volume control and ConnectLine (Optional)	24
	Change programs (optional)	26

	Other options (optional)	30
	Direct Audio Input (DAI)	31
	Wireless accessories (optional)	32
	Tamper-resistant battery drawer (optional)	34
<b>Warnings</b>	Warnings	36
<b>More info</b>	Troubleshooting guide	42
	Water resistant (IP58)	44
	Conditions	45
	Mobile phone	46
	Technical information	48
	Australia only	54
	Warranty	55

# Instrument view

## What it is

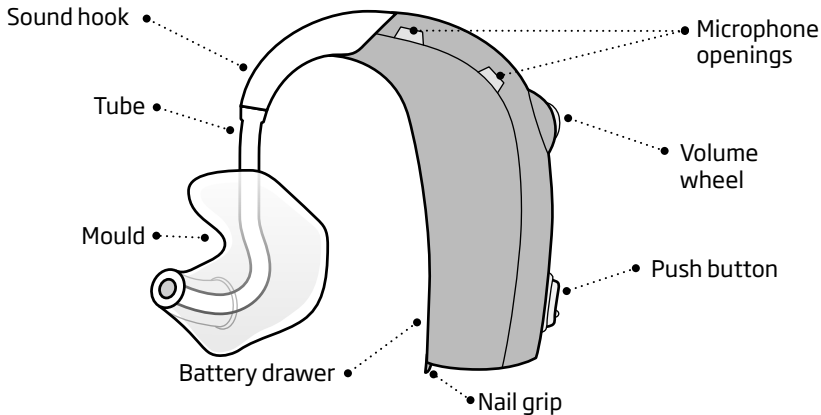

## What it does

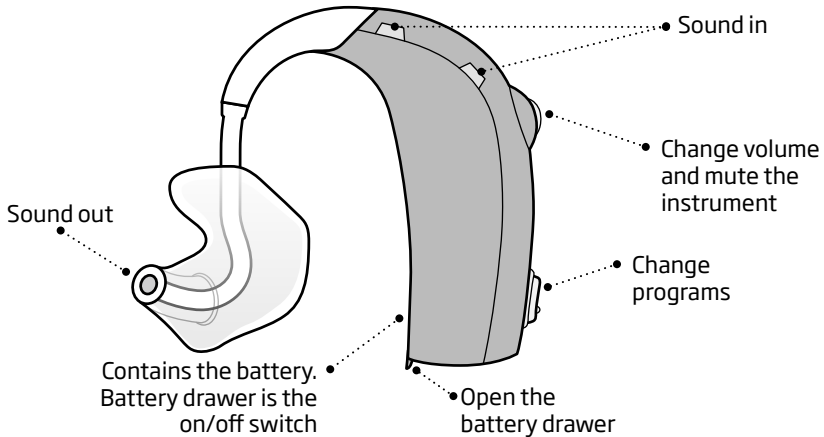

## Identify left and right hearing instrument

It is important to distinguish between the left and the right instrument as they might be programmed differently.

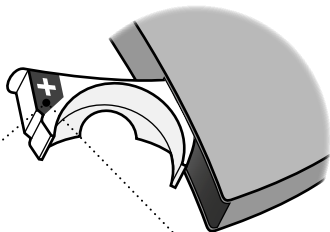

- A **BLUE** indicator inside the battery drawer marks the **LEFT** instrument.

- A **RED** indicator inside the battery drawer marks the **RIGHT** instrument



## Battery (size 13)

Your hearing instrument is a miniature electronic device that runs on special batteries. To activate the hearing instrument, you must insert a new battery in the battery drawer. See how in the “Replace the battery” section.

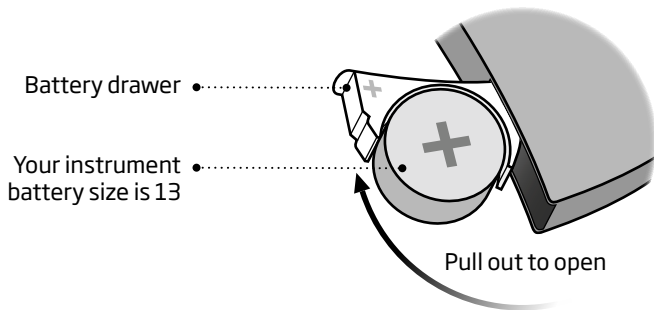

## Turn the hearing instrument on and off

The battery drawer is also used to switch the hearing instrument on and off. To preserve the battery, make sure your instrument is switched off when you are not wearing it.

### Turn ON

Close the battery drawer with the battery in place.

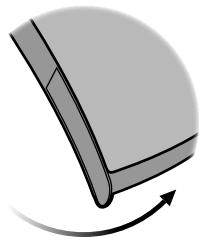

### Turn OFF

Open the battery drawer

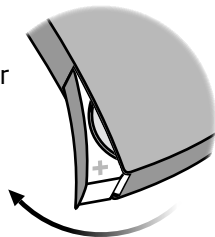

## When to replace a battery

When it is time to replace the battery you will hear two beeps repeated in moderate intervals until the battery runs out.



**Two beeps**

= The battery is running low



**Four beeps**

= The battery has run out

### Battery maintenance tip

To make sure the hearing instrument is always working bring spare batteries with you, or replace the battery before you leave home.

# How to replace the battery

## 1. Remove

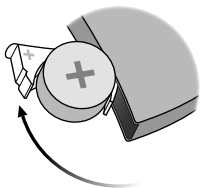

Fully open the battery drawer. Remove the battery.

## 2. Uncover

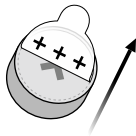

Remove the sticky label from the + side of the new battery.

## 3. Insert

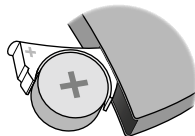

Insert the new battery into the battery drawer. Make sure the + side faces up.

#### 4. Close

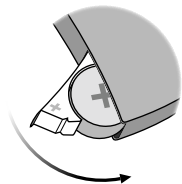

Close the battery drawer. The instrument will play a jingle through the ear piece. Hold the earpiece close to your ear to hear the jingle.

#### Tip

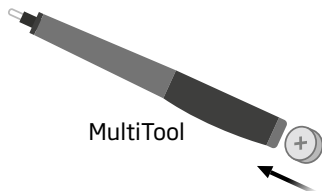

The MultiTool can be used for battery change. Use the magnetic end to remove and insert batteries.

The MultiTool is provided by your Hearing Care Professional.

## Caring for your hearing instrument

When handling your hearing instrument, hold it over a soft surface to avoid damage in case you drop it.

### Clean the microphone openings

Carefully brush away debris from the openings. Gently brush the surface. Make sure the brush is not pressed in to the openings.

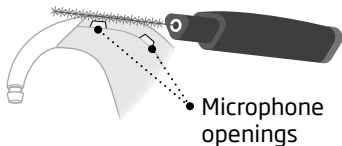

#### IMPORTANT NOTICE

Use a soft, dry cloth to clean the hearing instrument. It must never be washed or immersed in water or other liquids.

## The MultiTool

The MultiTool contains a brush and a wire loop for cleaning ear wax from the mould. The brush can be replaced and purchased from your Hearing Care Professional.

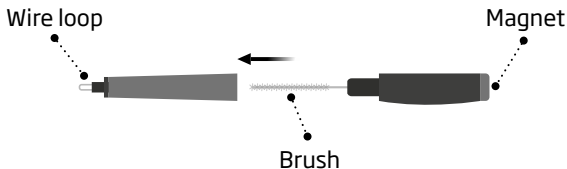

### **IMPORTANT NOTICE**

Your MultiTool has a built-in magnet. Keep the MultiTool 30 cm away from credit cards and other magnetically sensitive devices.

## Sound hook with mould

The mould is customised for you and fits your ear.

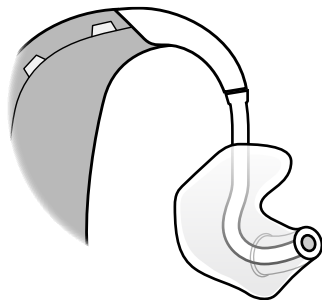



## Put on the hearing instrument with mould

Step 1



Gently pull your ear outwards and press the mould in the direction of the ear canal, twisting slightly.

Step 2



Place the hearing instrument behind your ear.

## Clean the mould

The mould should be cleaned regularly. Use a soft cloth to clean the surface of the mould. Use the MultiTool wire loop to clean the opening.

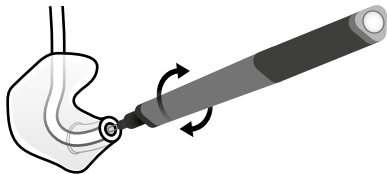

## Replace the tube

The tubing between the mould and the instrument should be replaced when it becomes yellow or stiff. Consult your Hearing Care Professional in relation to this.

## Wash the mould

### Step 1



Make sure you are able to identify which mould is for which instrument before disconnecting them from the instruments.

### Step 2

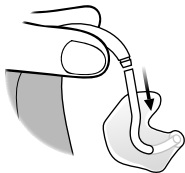

Disconnect the tube and mould from the hook. Hold the hook firmly, when pulling off the tube. Otherwise the instrument may be damaged.

### Step 3

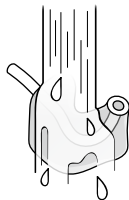

Wash the mould and tube using mild soap. Rinse and dry completely before reconnecting to the hearing instrument.

## Optional features and accessories

The features and accessories described on the following pages are optional. Please contact your Hearing Care Professional to find out how your hearing instrument is programmed.

If you experience difficult listening situations, a special program may be helpful. These are programmed by your Hearing Care Professional.

*Write down hearing situations where you may need help.*

---

---

---

## **Mute the hearing instrument** (optional)

Use the mute function if you need to silence the instrument while wearing it.

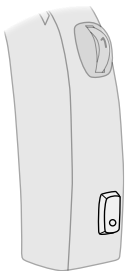

Apply a very long press to the button to mute the instrument. To reactivate the instrument, push the button briefly.

### **IMPORTANT NOTICE**

Do not use the mute function as an off switch, as the hearing instrument still draws current from the battery in this mode.

## Change volume

The volume wheel may be activated. The volume wheel allows you to adjust the volume in specific situations to the level you feel comfortable with.

The volume wheel has markings 1, 2, 3 and 4 and a 'click' position:

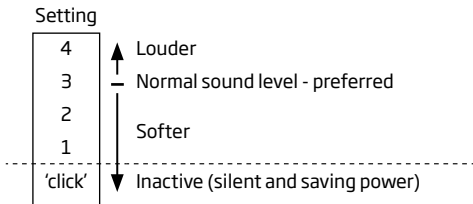

The normal volume wheel setting is 3. When adjusting the volume to the normal level you will hear a double beep.

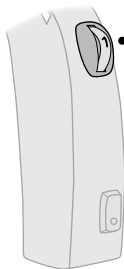

Use the volume wheel to mute the instrument by turning below setting one until it clicks. To reactivate the instrument, turn up on the volume wheel.

### **IMPORTANT NOTICE**

Do not use the inactive 'click' position as an off switch as the hearing aid still draws power from the battery in this mode.

## **Volume control and ConnectLine** (Optional)

Make sure to set the volume control on the instrument in the 1 to 4 range to enable use of the Streamer for remote control, phone calls and TV/music streaming. Streaming cannot be initiated while the instrument volume wheel is set to the inactive 'click' position.

If you use the Streamer to adjust the regular hearing instrument listening volume, the resulting volume will no longer match the indications on the volume wheel. Turning the volume wheel to the inactive 'click' position and back into the 1-4 range or turning the instrument off and back on will reset the volume to the setting indicated on the volume wheel.



When adjusting the volume to the preferred level you will hear a double beep.

During audio streaming, adjust the volume on the Streamer. The Streamer will control the volume independently of the setting of the volume wheel.

## □ **Change programs** (optional)



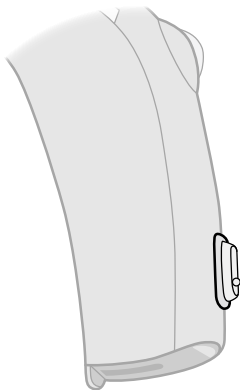

Your hearing instrument can have up to 4 different programs. These are programmed by your Hearing Care Professional.



• Press the button to change program

Note that if you have two instruments, the RIGHT instrument switches forward from e.g. program 1 to 2 and the LEFT instrument switches backwards from e.g. program 4 to 3.

## To be filled out by the Hearing Care Professional

Program	Sound you will hear when activated	When to use
1	 "1 beep"	
2	 "2 beeps"	
3	 "3 beeps"	
4	 "4 beeps"	

Program change:	<input type="checkbox"/> LEFT	<input type="checkbox"/> RIGHT	<input type="checkbox"/> Short press	<input type="checkbox"/> Long press
-----------------	-------------------------------	--------------------------------	--------------------------------------	-------------------------------------

## Quick reset

If you wish to return to the standard settings of the instrument programmed by your Hearing Care Professional, simply open and then close the battery drawer.

Open

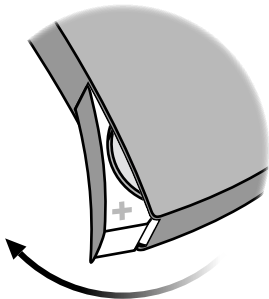

Close

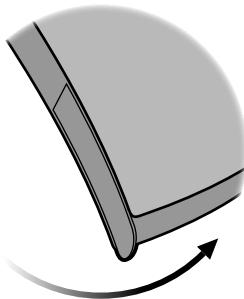

Note that volume setting is not changed with the quick reset.



## **Other options** (optional)



### **Telecoil**

Telecoil helps you hear better when using a telephone with a built-in loop or when you are in buildings with teleloop systems such as theatres, churches or lecture rooms. This symbol or a similar sign is shown wherever a teleloop has been installed.



### **Autophone**

Autophone can automatically activate a phone program in the hearing instrument, if your telephone has a dedicated magnet. The magnet needs to be placed on your telephone next to the sound outlet.

## **Direct Audio Input (DAI)**

DAI allows your hearing instrument to receive signals directly from external sources such as TV, radio, music players, etc. The DAI adaptor is mounted to your instrument and via a cable connected to an external sound source.

For detailed information on these options contact your Hearing Care Professional or visit [www.oticon.com.au](http://www.oticon.com.au)

### **IMPORTANT NOTICE**

Only connect hearing aids with DAI to electrically powered devices that comply with EN 60950-1, EN 60065 or equivalent safety standards. The external signal source determines the safety of hearing aids with DAI.

## **Wireless accessories** (optional)

As an enhancement to your wireless hearing instrument a broad range of wireless accessories are available.

### **ConnectLine**

ConnectLine is a family of products that allows you to receive audio signals from TVs, phones, music players, PCs or an external microphone wirelessly through your hearing instrument.

### **Remote Control**

The Remote Control offers an opportunity to change program or adjust the volume or mute your hearing instrument.



## **FM**

Your hearing instrument supports the option of attaching an FM system. The FM system allows you to receive speech or audio signals directly to your hearing instrument from a dedicated transmitter.

For detailed information on wireless accessories contact your Hearing Care Professional or visit **[www.oticon.com.au](http://www.oticon.com.au)**

## **Tamper-resistant battery drawer** (optional)

To keep the battery out of reach of infants, small children and people with learning difficulties, a tamper-resistant battery drawer should be used. Use a small screwdriver to lock and unlock the drawer.

### **IMPORTANT NOTICE**

Avoid excessive force to open the battery drawer when in the locked position. Do not force the battery drawer beyond its fully opened position. Make sure to insert the battery correctly.

Please contact your Hearing Care Professional if you suspect the tamper-resistant effectiveness and locking ability is damaged.

## Unlock the battery drawer

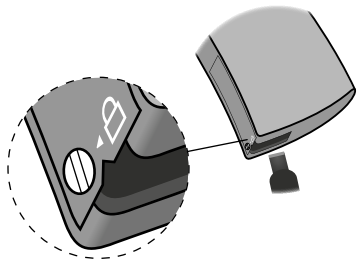

Use the screwdriver to turn the screw to unlock position (vertical). Insert the screwdriver into the slit in the bottom of the hearing instrument and push the drawer open.

## Lock the battery drawer

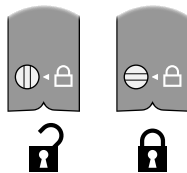

Make sure the drawer is completely closed. Turn the screw to the locked position (horizontal).

## **Warnings**

You should familiarise yourself fully with the following general warnings before using your hearing instrument for personal safety and to secure correct use.

Please note that a hearing aid will not restore normal hearing and will not prevent or improve a hearing impairment resulting from organic conditions. Furthermore, note that in most cases, infrequent use of a hearing instrument does not permit a user to attain full benefit from it.

Consult your Hearing Care Professional if you experience unexpected operations or events with your hearing instrument.

### **Usage of hearing instruments**

- Hearing instruments should be used only as directed and adjusted by your Hearing Care Professional. Misuse can result in sudden and permanent hearing loss.
- Never allow others to wear your hearing instrument as incorrect use could cause permanent damage to their hearing.

### **Choking hazards & risk of swallowing batteries**

- Hearing instruments, their parts, and batteries should be kept out of reach of children and anyone who might swallow these items, or otherwise cause injury to themselves.

- Batteries have occasionally been mistaken for pills. Therefore, check your medicine carefully before swallowing any pills.
- Most hearing instruments can be supplied with a tamper-resistant battery drawer upon request. This is strongly recommended for infants, small children and people with learning difficulties.
- Children below 36 months must always use a tamper-resistant battery drawer. This option is available in BTE, miniBTE, RITE and miniRITE instruments.

*If a battery or hearing instrument is swallowed, see a doctor immediately.*

### **Battery use**

- Always use batteries recommended by your Hearing Care Professional. Batteries of low quality may leak and cause bodily harm.
- Never attempt to recharge your batteries and never dispose of batteries by burning them. There is a risk that the batteries will explode.

## **Warnings**

### **Dysfunction**

- Be aware of the possibility that your hearing instrument may stop working without notice. Keep this in mind when you depend on warning sounds (e.g. when you are in traffic). The hearing instruments may stop functioning, for instance if the batteries have expired or if the tubing is blocked by moisture or ear wax.

### **Active implants**

- Caution must be taken with active implants. In general, follow the guidelines recommended by manufacturers of implantable defibrillators and pacemakers regarding use with mobile phones and magnets.

- Your hearing instrument has a wireless transmission. Please keep the hearing instrument at least 15 cm away from the implant, e.g. do not carry it in a breast pocket.
- When the hearing instruments are mounted on or in the ears, the distance between the hearing instruments and the implant is larger than 15 cm.
- Your Autophone magnet and MultiTool (which has a built-in magnet) should be kept more than 30 cm away from the implant e.g. do not carry it in a breast pocket.

- If you have an active brain implant, please contact the manufacturer of your implantable device for information about the risk of disturbance.

### **Explosives**

- The power source in your hearing instrument has insufficient energy to cause fire in normal usage conditions. The hearing instrument has not been tested for compliance with international standards concerning explosive environments.

It is recommended not to use your hearing instrument in areas where there is a danger of explosions.

### **X-ray, CT, MR, PET scanning and electrotherapy**

- Remove your hearing instrument for example during X-ray, CT/MR/PET scanning electrotherapy or surgery as your hearing instrument may be damaged when exposed to strong fields.

## **Warnings**

### **Avoiding heat and chemicals**

- Your hearing instrument must never be exposed to extreme heat e.g. left inside a parked car in the sun.
- Your hearing instrument must not be dried in microwave ovens or other ovens.
- The chemicals in cosmetics, hairspray, perfume, aftershave lotion, suntan lotion and insect repellent can damage your hearing instrument. Always remove your hearing instrument before applying such products and allow time to dry before putting it on.

### **Power instrument**

- This is a power instrument and special care should be exercised in selecting, fitting and using a hearing instrument where maximum sound pressure capability exceeds 132 dB SPL (IEC 711), as there may be risk of impairing the remaining hearing of the hearing instrument user.

### **Possible side effects**

- Hearing instruments, moulds or domes may cause an accelerated accumulation of ear wax.



- The otherwise non-allergenic materials used in hearing instruments may in rare cases cause a skin irritation or any other unusual condition.

*Please seek consultation with a physician if these conditions occur.*

### **Interference**

- Your hearing instrument has been thoroughly tested for interference, according to the most stringent international standards. However, interference with your hearing instrument and other devices may occur, (e.g. some mobile telephones, citizens band systems and shop alarm systems). If this occurs, increase the distance between the hearing instrument and the device.



### **WARNING**

New and used button/coin batteries are hazardous and should be kept away from children. Button/coin batteries can cause severe or fatal injuries in 2 hours or less if swallowed or placed inside any part of the body. Seek medical attention immediately if this is suspected.

If it is suspected a button/coin battery has been swallowed or otherwise placed inside any part of the body, you should contact the

Australian Poisons Information Centre  
on 13 11 26

New Zealand National Poisons Centre  
on 0800 764 766  
immediately for 24/7 fast, expert advice.

## Troubleshooting guide

Symptom	Possible causes
<b>No sound</b>	Worn-out battery
	Clogged tube or earpieces
<b>Intermittent or reduced sound</b>	Clogged sound outlet
	Moisture
	Worn-out battery
	Clogged damping filter in sound hook
<b>Squealing noise</b>	Hearing instrument earpiece inserted incorrectly
	Ear wax accumulated in ear canal

If none of the above solutions works, consult your Hearing Care Professional for assistance.

## Solutions

Replace the battery

Clean mould

Clean mould

Wipe battery with a dry cloth and/or dry tube

Replace the battery

Contact your Hearing Care Professional for assistance

Re-insert earpiece (mould)

Have ear canal examined by your doctor

## Water resistant (IP58)

Your hearing instrument is water resistant, which means it is designed to be worn in all daily life situations. Therefore, you do not have to worry about sweat or getting wet in a rain shower. Should your hearing instrument come in contact with water and stop working, please follow these guidelines:

1. Gently wipe off any water
2. Open the battery drawer and remove the battery and gently wipe off any water in the battery drawer
3. Let the hearing instrument dry with the battery drawer left open for approximately 30 minutes
4. Insert a new battery

### IMPORTANT NOTICE

Do not wear your hearing instrument while showering or participating in water activities. Do not immerse your hearing instrument in water or other liquids.

## Conditions

<b>Operating conditions</b>	Temperature: +1°C to +40°C Relative humidity: 5% to 93%, non-condensing
<b>Storage and transportation conditions</b>	Temperature and humidity shall not exceed the below limits for extended periods during transportation and storage:  Temperature: -25°C to +60°C Relative humidity: 5% to 93%, non-condensing

## Mobile phone

Some hearing instrument users have reported a buzzing sound in their hearing instrument when they are using mobile phones, indicating that the mobile phone and hearing instrument may not be compatible.

The ANSI C63.19 standard determines the prediction of compatibility between a specific hearing instrument and a mobile phone by: adding the numerical value of the rating for the hearing instrument immunity to the numerical value of the rating for the mobile phone emissions. A sum of 4 would indicate that the combination of wireless device and hearing instrument is usable; a combined rating that equals at least 5 would provide normal use;

a combined rating of 6 or greater would indicate excellent performance.

Whereas all hearing instruments have acoustic coupling, only the larger instruments have the physical space for telecoil (inductive) coupling. These two types of coupling have different rating scales (M1-M4 for acoustic coupling and T1-T4 for telecoil coupling, respectively) and both ratings are therefore relevant when predicting the compatibility of a particular hearing instrument.

For a hearing instrument with both acoustic coupling and telecoil coupling with a rating of M4/T2 and with a telephone rating of M3/T3), the

combined rating is 7 (M4 + M3) for the acoustic coupling and 5 (T2 + T3) for the telecoil coupling. According to the guidelines given above, both types of coupling will thereby be acceptable, with the acoustic coupling indicating excellent performance and the telecoil coupling indicating normal use.

The above equipment performance measurements, categories and system classifications are based upon the best information available, but it cannot be guaranteed that all users will be satisfied.

The immunity of this hearing instrument is M4/T4.

### **IMPORTANT NOTICE**

The performance of individual hearing instruments may vary with individual mobile phones. Therefore, please try this hearing instrument with your mobile phone or, if you are purchasing a new phone, be sure to try it with your hearing instrument prior to purchase.

For additional guidance, please ask your mobile phone provider for the booklet entitled "Hearing Aid Compatibility with Digital Wireless Cell Phones."

## Technical information

The hearing instrument contains a radio transmitter using short range magnetic induction technology working at 3.84 MHz. The magnetic field strength of the transmitter is  $< -42 \text{ dB}\mu\text{A/m @ 10m}$ .

The emission power from the radio system is well below international emission limits for human exposure. For comparison, the radiation of the hearing instrument is lower than unintended electromagnetic radiation from, for example, halogen lamps, computer monitors, dishwashers, etc. The hearing instrument complies with international standards concerning Electromagnetic Compatibility.

Due to the limited space available on the instruments, all relevant approval markings are found in this document.

Additional information can be found in the Product Information sheet on [www.oticon.com.au](http://www.oticon.com.au)



The hearing instrument contains a module with:

FCC ID: U28FU2SP

IC: 1350B-FU2SP

The device complies with Part 15 of the FCC rules and RSS-210 of Industry Canada.

Operation is subject to the following two conditions:

1. This device may not cause harmful interference.
2. This device must accept any interference received, including interference that may cause undesired operation.

Changes or modifications not expressly approved by the party responsible for compliance could void the user's authority to operate the equipment.

Oticon declares that this hearing instrument is in compliance with the essential requirements and other relevant provisions of Directive 1999/5/EC.

Declaration of Conformity is available from the manufacturer.



Manufactured by:  
Oticon A/S  
Kongebakken 9  
DK-2765 Smørum  
Denmark  
[www.oticon.global](http://www.oticon.global)

CE 0543 0682



Waste from electronic equipment must be handled according to local regulations.



E2831



**Australian Sponsor**

Audmet Australia Pty Ltd  
Suite 4, Level 4, Building B  
11 Talavera Road  
North Ryde NSW 2113

## International warranty

Your device is covered by an international limited warranty issued by the manufacturer for a period of 12 months from the date of delivery to you. This limited warranty covers manufacturing and material defects in the device itself, but not in accessories such as batteries, tubing, speakers, earpieces and filters, etc. Problems arising from improper/incorrect handling or care, excessive use, accidents, repairs made by an unauthorised party, exposure to corrosive conditions, physical changes in your ear, damage due to foreign objects entering the device, or incorrect

adjustments are NOT covered by the limited warranty and may void it. Under this warranty, the manufacturer will choose, at its sole discretion, whether to repair the device, or replace it with an equivalent model. The above warranty does not affect any legal rights that you might have under applicable national legislation governing sale of consumer goods. Your hearing care professional may have issued a warranty that goes beyond the clauses of this limited warranty. Please consult him/her for further information.

**If you need service**

Take your device to your hearing care professional, who may be able to sort out minor problems and make adjustments immediately. Your hearing care professional can assist you to obtain warranty service from the manufacturer. Your hearing care professional may charge a fee for their services.

More information: [www.oticon.com.au](http://www.oticon.com.au)

## Australia only

The rights given under this warranty are in addition to other rights and remedies under a law in relation to the good or services to which the warranty relates to. Our goods come with guarantees that cannot be excluded under the Australian Consumer Law. You are entitled to a replacement or refund for a major failure and compensation for any other reasonably foreseeable loss or damage. You are also entitled to have the goods repaired or replaced if the goods fail to be of acceptable quality and the failure does not amount to a major failure.

Australian customers should contact Oticon Australia at Suite 4, Level 4, Building B, 11 Talavera Road, North Ryde NSW 2113, telephone 1800 633 738 if you have any questions regarding this warranty.

# Warranty

## Certificate

Name of owner: \_\_\_\_\_

Hearing care professional: \_\_\_\_\_

Hearing care professional's address: \_\_\_\_\_

Hearing care professional's phone: \_\_\_\_\_

Purchase date: \_\_\_\_\_

Model left: \_\_\_\_\_ Serial no.: \_\_\_\_\_

Model right: \_\_\_\_\_ Serial no.: \_\_\_\_\_

## Settings overview for your hearing instrument

Left			Right	
<input type="checkbox"/> Yes	<input type="checkbox"/> No	Volume wheel	<input type="checkbox"/> Yes	<input type="checkbox"/> No
<input type="checkbox"/> Yes	<input type="checkbox"/> No	Program shift	<input type="checkbox"/> Yes	<input type="checkbox"/> No
<input type="checkbox"/> Yes	<input type="checkbox"/> No	Mute	<input type="checkbox"/> Yes	<input type="checkbox"/> No
Volume wheel indicators				
<input type="checkbox"/> On	<input type="checkbox"/> Off	Beeps at min /max volume	<input type="checkbox"/> On	<input type="checkbox"/> Off
<input type="checkbox"/> On	<input type="checkbox"/> Off	Clicks when changing volume	<input type="checkbox"/> On	<input type="checkbox"/> Off
<input type="checkbox"/> On	<input type="checkbox"/> Off	Beeps at preferred volume	<input type="checkbox"/> On	<input type="checkbox"/> Off
Battery indicators				
<input type="checkbox"/> On	<input type="checkbox"/> Off	Low battery warning	<input type="checkbox"/> On	<input type="checkbox"/> Off
<input type="checkbox"/> On	<input type="checkbox"/> Off	Change battery	<input type="checkbox"/> On	<input type="checkbox"/> Off







**oticon**  
life-changing **technology**