



PHILIPS

Philips HearLink - bulk supplies order form

miniFit speakers *for MNR | MNR T | MNR T R*

60-Speaker units		
QTY	Item # / description	Notes
	149271 SPEAKER UNIT, 1R	
	149272 SPEAKER UNIT, 1L	
	149273 SPEAKER UNIT, 2R	
	149274 SPEAKER UNIT, 2L	
	149275 SPEAKER UNIT, 3R	
	149276 SPEAKER UNIT, 3L	
	149277 SPEAKER UNIT, 4R	
	149278 SPEAKER UNIT, 4L	
		Each box contains: - one speaker unit - one ear grip

85-Speaker units		
QTY	Item # / description	Notes
	149279 SPEAKER UNIT, 1L	
	149280 SPEAKER UNIT, 1R	
	149281 SPEAKER UNIT, 2L	
	149282 SPEAKER UNIT, 2R	
	149283 SPEAKER UNIT, 3L	
	149284 SPEAKER UNIT, 3R	
	149285 SPEAKER UNIT, 4L	
	149286 SPEAKER UNIT, 4R	
		Each box contains: - one speaker unit - one ear grip

100-Speaker units		
QTY	Item # / description	Notes
	149287 SPEAKER UNIT, 1L	
	149288 SPEAKER UNIT, 1R	
	149289 SPEAKER UNIT, 2L	
	149290 SPEAKER UNIT, 2R	
	149291 SPEAKER UNIT, 3L	
	149292 SPEAKER UNIT, 3R	
	149293 SPEAKER UNIT, 4L	
	149294 SPEAKER UNIT, 4R	
		Each box contains: - one speaker unit



105 Power-speaker wires		
QTY	Item # / description	Notes
	149302 SPEAKER WIRE, 1L	
	149301 SPEAKER WIRE, 1R	
	149300 SPEAKER WIRE, 2L	
	149299 SPEAKER WIRE, 2R	
	149298 SPEAKER WIRE, 3L	
	149297 SPEAKER WIRE, 3R	
	149296 SPEAKER WIRE, 4L	
	149295 SPEAKER WIRE, 4R	
		For custom power mold fittings embedded with the 105 power-speaker



miniFit thin tubes *for BTE PP, miniBTE T, miniBTE T R*

Thin tube 0.9mm		
QTY	Item # / description	Notes
	156522 TUBE SET, 5PCS, 0L	
	156526 TUBE SET, 5PCS, 0R	
	156523 TUBE SET, 5PCS, 1L	
	156527 TUBE SET, 5PCS, 1R	
	156524 TUBE SET, 5PCS, 2L	
	156528 TUBE SET, 5PCS, 2R	
	156525 TUBE SET, 5PCS, 3L	
	156529 TUBE SET, 5PCS, 3R	
		Each box contains: - five thin tubes - five ear grips

Thin tube 1.3mm		
QTY	Item # / description	Notes
	156533 TUBE SET, 5PCS, 0L	
	156537 TUBE SET, 5PCS, 0R	
	156534 TUBE SET, 5PCS, 1L	
	156538 TUBE SET, 5PCS, 1R	
	156535 TUBE SET, 5PCS, 2L	
	156539 TUBE SET, 5PCS, 2R	
	156536 TUBE SET, 5PCS, 3L	
	156540 TUBE SET, 5PCS, 3R	
		Each box contains: - five thin tubes - five ear grips

miniFit domes for BTE PP, MNR, MNR T, MNR T R, MNB T, MNB T R

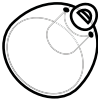
QTY	Item # / dome set	Image
	218357 OPENBASS, 5MM	
	218361 OPENBASS, 6MM	
	218366 OPENBASS, 8MM	
	218370 OPENBASS, 10MM	
	218375 OPENBASS, 12MM	
	149303 OPEN, 6MM	
	149304 OPEN, 8MM	
	149305 OPEN, 10MM	

QTY	Item # / dome set	Image
	149306 BASS DOUBLE, 6MM	
	149307 BASS DOUBLE, 8MM	
	149308 BASS DOUBLE, 10MM	
	149309 BASS DOUBLE, 12MM	
	149314 POWER, 6MM	
	149315 POWER, 8MM	
	149316 POWER, 10MM	
	149317 POWER, 12MM	

Section comments

- Please indicate the number of individual packs of domes in "QTY". (1) complete master box contains 10 packs of domes.





196147 miniFit speaker kit for MNR, MNR T, MNR T R

QTY	Item # / description	Image
	<p>miniFit Speaker units (1 ea.): 2L 60, 2R 60, 3L 60, 3R 60, 2L 85, 2R 85, 3L 85, 3R 85</p> <p>miniFit Domes (10 ea.): OpenBass 5mm, OpenBass 6mm, OpenBass 8mm, OpenBass 10mm, Bass Double 8mm, Bass Double 10mm</p> <p>Tools (1 ea.): LiteTip 60, LiteTip 85, tool for plug, multitool for valve, multi-tool for extension, cardboard measurement tool (2x)</p> <p>Plugs (3 ea.): Faceplate blue, Faceplate red</p> <p>Cleaning (1 ea.): ProWax system, wax protection set</p>	







196154 miniFit thin tube kit for BTE PP, miniBTE T, miniBTE T R

QTY	Item # / description	Image
	<p>miniFit 0.9 tube sets (2 ea.): 0L, 0R, 1L, 1R, 2L, 2R, 3L, 3R</p> <p>miniFit 1.3 tube sets (3 ea.): 0L (only 2x), 0R (only 2x), 1L, 1R, 2L, 2R, 3L (only 2x), 3R (only 2x)</p> <p>miniFit Domes (10 ea.): Open 6mm, Open 8mm, Open 10mm, Bass Double 6mm, Bass Double 8mm, Bass Double 10mm, Bass Double 12mm, Power 6mm, Power 8mm, Power 10mm, Power 12mm</p> <p>Tools: ear grip (10x), cleaning set (20x), hook for BTE PP (5x), cardboard measurement tool (1x), thin tube adapter for BTE PP (5x), disassembly tool for lock pin (1x), neutral cleaning set (1x)</p>	

Other accessories

QTY	Item # / description	Image	Comments
	149876 EAR GRIP, 60-SPEAKER		Ear grips (5x) Ear grip lock (10x)
	149877 EAR GRIP, 85-SPEAKER		
	156570 EAR GRIP LOCK FOR THIN TUBE		
	143070 TOOL FOR PLUG		Attach/ detach 105-speaker to power mold
	890-22-270-00 DISASSEMBLY TOOL FOR LOCK PIN		To push pins out of the BTE PP and open MNR T R battery doors
	890-60-232-00 VALVE MULTI-TOOL		Tool with vent cleaner, screwdriver, and magnet
	890-60-320-00 EXTENSION MULTI-TOOL		To be used with multi-tool

Other accessories (contd.)

QTY	Item # / description	Image	Comments
	890-21-291-00 CARDBOARD MEAS. TOOL FOR SPEAKERS		Tool to measure the correct speaker wire length
	890-21-222-00 CARDBOARD MEAS. TOOL FOR THIN TUBES		Tool to measure the correct thin tube length
	130091 PROWAX PROTECTION SET, FOR MINIFIT		For 1 box of 10, indicate "10" in "QTY". For hearing aid receivers.
	123459 PROWAX PROTECTION SET, FOR EAR MOLDS ONLY		For 1 box of 10, indicate "10" in "QTY". For ear molds only.
	203479 POWER SUPPLY, 5.0V/1A *A USB-A		Charger with components for the USA, Canada, and Japan.
	263516 T-CAP MIC COVER - BLACK		For 1 box of 5, indicate "1" in "QTY" column. For IIC/ CIC custom devices.
	263514 T-CAP MIC COVER - DARK BROWN		
	263512 T-CAP MIC COVER - MEDIUM BROWN		
	263513 T-CAP MIC COVER - LIGHT BROWN		
	263515 T-CAP MIC COVER - BEIGE		
	254999 O-CAP MIC COVER - BLACK		For 1 box of 5, indicate "1" in "QTY" column. For ITC/ ITE custom devices.
	128012 O-CAP MIC COVER - DARK BROWN		
	128011 O-CAP MIC COVER - MEDIUM BROWN		
	128010 O-CAP MIC COVER - LIGHT BROWN		
	128009 O-CAP MIC COVER - BEIGE		

POS and training materials

Physical/ printed materials	
QTY	Item # / description
	262773 IFU, 9040 MNR T T R
	262750 IFU, 9040 MNB T T R
	213738 IFU, TV ADAPTER
	214524 IFU, REMOTE CONTROL
	220574 IFU, AUDIOCLIP
	217326 IFU, MNR T R DESK. CHARGER
	235376 IFU, MNR T R CHARGER PLUS
	243751 IFU, MNB T R DESK. CHARGER
	243727 IFU, MNB T R CHARGER PLUS
	980-93-001-00 UPS LABELS
	980-93-002-00 UPS BAGS
	15500-9730 UPS IMP. BOXES

Physical/ printed materials(contd.)			
QTY	Item # / description	QTY	Item # / description
	900128 23.2 PRODUCT INSERT CARD		900130 CONSUMER BROCH. 25PK

Digital materials (not printed)		https://uscostco.sbohearing.com/
900084 CUSTOMS COUNSELING		900113 COLOR CHART
900090 BTE ORDER FORM		900115 MICROSHELL FORM
900095 REMOTE FIT. CHECKLIST		900117 REMOTE FIT. GUIDE
900100 CONNECTIVITY GUIDE		900120 APPLES-TO-APPLES
900101 ACCESSORIES SHEET		900121 EARMOLD ORDER FORM
900102 ACOUSTIC GUIDE		900123 HEARLINK 2 APP GUIDE
900107 9040 TRAINING SHEET		900124 CUSTOMS ORDER FORM
900108 FINE-TUNING GUIDE		900127 BULK SUPPLIES FORM
900109 FIRST-FIT GUIDE		

Shipping information

CHAC # CHAC city, state

Name of Costco hearing care professional:

Comments: